

# EXTRACTION CHROMATOGRAPHY

## Technical Documentation



Extraction chromatographic resins



Specialty ion exchange resins



Analytical grade ion exchange resins



Discs and filters for sample preparation

Visit our new web site: [www.triskem.com](http://www.triskem.com)

Expertise in Separation Chemistry

23 2 99 05 00 09

OUR PRODUCTS - TECHNICAL SUPPORT - TRISKEM - CONTACT

REAGENTS FOR ENVIRONMENTAL MONITORING, BIOASSAY, GEOCHEMISTRY, RADIOPHARMACY AND DECOMMISSIONING

READ MORE

### OUR PRODUCTS

Triskem is the leading European manufacturer and provider of highly specific resins for use in radiochemistry and metals separation. It further provides equipments and accessories used in radiochemical analysis.

- Resins and accessories**  
Specialized ion exchange resins for radiochemistry and ion exchange product lines, and analytical accessories.
- Pyrolyser**  
Miniaturized for field use, pyrolyser products and their application to H-3 and C-14 analysis.
- LSC Consumables**  
Triskem is producing Triskem-Geochem resins line of LSC cocktails and vials.
- NucFilm Discs**  
Radioforming for alpha emitters such as Ra-226 using NucFilm Discs.
- Support**  
Access to technical documentation, FAQ, our TSO newsletter and custom and pre-consultations.
- Service**  
We are at your service for any technical or administrative questions.

**Environmental Monitoring and Bioassay**

**Radiopharmacy and Nuclear Medicine**

**Geochemistry and Metals Separation**

**Decommissioning**

### Expertise in Separation Chemistry

**Identity:** Strongly customer-oriented, TRK is dedicated to high quality development and production of innovative technologies from laboratory to semi industrial scale.

**Core values:** We commit our competences and expertise in separation chemistry to solve complex challenges in analytical and radiochemistry, nuclear medicine, decommissioning, hydrometallurgy and other domains requiring highly selective solutions.

**Vision:** Our ambition is to become the global leader in developing and manufacturing products and solutions for complex inorganic separations. **Requests for environmental monitoring, bioassay, geochemistry, radiopharmacy and decommissioning.**

**Triskem International** develops, produces and markets the **resins** used for **radioactivity analysis** in environmental, medical, bioassay and waste matrices. Triskem International markets **radioactive separation solutions** and applications for nuclear medicine and radiopharmacy.

Our main product line of **radioactive chemistry reagents** which allow the separation of radionuclides and elements from various samples and matrices (environmental, medical and bioassay samples, dissolved targets as well as waste samples).

Our products are a standard technology in radiochemistry used by **international accredited laboratories and monitoring agencies.**

# INDEX

Company.....	4
Extraction Chromatography.....	5
Applications.....	7
Extraction Chromatographic Resins.....	8
UTEVA Resin.....	8
TRU Resin.....	9
TEVAResin.....	10
SR Resin.....	11
PB Resin.....	13
DGA Resin.....	14
DGA Sheets.....	16
LN Resin Series.....	17
NI Resin.....	18
RE Resin.....	18
CL Resin.....	19
CU Resin.....	20
ZR Resin.....	21
TBP Resin.....	22
TK100 Resin & TK101 Resin.....	25
TK200.....	28
TK400.....	30
AC Resin.....	32
Prefilter Resin.....	32
WBEC Resin.....	33
Specialty Ion Exchange Resins.....	34
MnO <sub>2</sub> and MnO <sub>2</sub> PAN Resin.....	34
CS Resins.....	36
Ion Exchange Resins.....	37
Analytical Grade ANION and CATION EXCHANGE Resins.....	37
MONOPHOS Resin.....	37
TRITIUM Columns.....	38
Sample Preparation.....	39
Nucfilm Discs.....	39
Resolve™ Filters.....	39
Discs for alpha spec source preparation.....	39
Accessories.....	40
Vacuum box and accessories.....	40
Column accessories.....	40
ICP-MS standards and consumables.....	40
Bio-Safe PEEK columns.....	40
Pyrolyser furnace and Mini Pyroliser.....	41
References.....	42



TrisKem International develops, manufactures and commercializes **highly selective resins** for the separation of a large variety of elements in numerous domains.

Triskem Resins are used for:

- the analysis of precious samples (environmental monitoring, radiation protection, bioassay)
- the recuperation of high value elements (production of radio metals for medical use and recuperation of their respective target materials and recovery of critical metals)
- the high precision determination of isotope ratios (dating/ geochronology)
- the removal of particular elements before effluent release
- quality control of final and intermediary products in numerous industries including radiopharmacy

We also commercialize a complementary **range of accessories** such as vacuum box systems and products used for sample preparation like LSC cocktails, filters and discs for alpha spectrometry, and Pyrolyser systems for the determination of H-3, C-14, Cl-36, I-129,... in a variety of matrices including decommissioning samples.

Our technical support is carried out by a **worldwide recognized scientific team** consisting of radiochemistry PhDs who are amongst others members of the French nuclear equipment standardization agency (BNEN), ISO workgroups, and external IAEA experts and lecturers.

TrisKem International products have now become **the standard technology** in the field of radiochemistry, geochemistry and radiopharmacy with methods used by accredited laboratories (AREVA, BNFL, CEA,>NNL,...) and regulatory organizations (IRSN, IAEA, BGRM,...) and many other customers working on radionuclide and element separation and purification.

# EXTRACTION CHROMATOGRAPHY

Extraction chromatography (EXC) is a technique that is ideally suited to the separation of radionuclides from a wide range of sample types. This technique combines the selectivity of liquid-liquid extraction with the ease of operation of column chromatography.

$$[1] \quad k' = D \cdot \frac{V_s}{V_m}$$

where  $v_s$  and  $v_m$  are the volumes of stationary and mobile phases, respectively.

Surface of Porous Bead

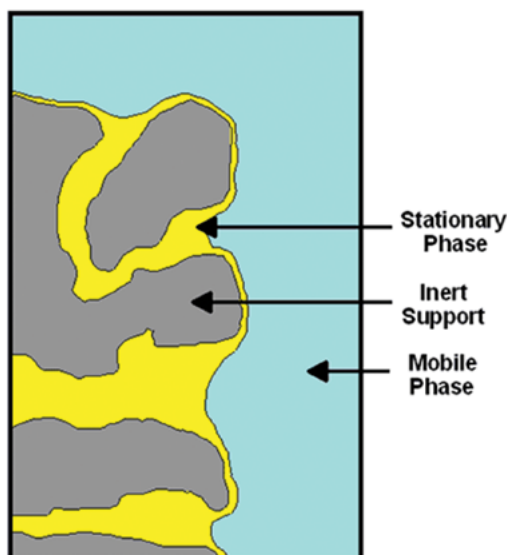

Resin Bead



## Principles

The figure hereunder is a simplified depiction of a portion of an extraction chromatographic resin bead showing the three major components of an EXC system: the inert support, the stationary phase, and the mobile phase. Liquid extractants, either single compounds or mixtures, are used as the stationary phase. Diluents can also be used to help to solubilize the extractant and to increase the hydrophobicity of the stationary phase.

The mobile phase is usually an acid solution, e.g., nitric or hydrochloric acid, although complexants, such as oxalic or hydrofluoric acids, are frequently used to enhance selectivities or the stripping of strongly retained metal ions from columns.

The relationship between the distribution ratio ( $D$ ) as measured in a solvent extraction (SX) system and the number of free column volumes to peak maximum,  $k'$ , for the corresponding EXC system is shown in the following equation.

It is important to note the concentration of extractant is usually much higher in EXC systems where diluents may be absent altogether than in conventional SX systems. Therefore,  $D$  and  $k'$  are not usually measured directly for EXC systems, but calculated from the weight distribution ratio,  $D_w$ , which is easily measured.

The weight distribution ratio,  $D_w$ , is obtained by measuring the amount of a given metal ion taken up by a measured weight of resin from a given volume of aqueous solution. In the studies described in this report, radioactive isotopes were used to measure the uptake of metal ions. The weight distribution ratio is then calculated using the following equation :

$$[2] \quad D_w = \frac{A_0 - A_s}{A_s} \cdot \frac{\text{mL}}{\text{g}}$$

where  $A_0 - A_s$  = activity sorbed on a known weight of resin (g), and  $A_s$  = the activity in a known volume (mL) of solution.

The volume distribution ratio  $D$  is calculated from the volume of stationary phase per gram divided into  $D_w$ . The volume of stationary phase is obtained from its weight percent sorbed on the inert support and its density (the density of the stationary phase is obtained from an independent measurement.) The number of free column volumes to peak maximum,  $k'$ , is then calculated from equation (1). The quantities,  $v_s$  and  $v_m$ , are measured from the weight of resin required to fill a column to a known volume and the density of the EXC resin.

Details for the calculation of  $D$  and  $k'$  and the independent measurement of  $v_s$  and  $v_m$  can be found in Table 1 gives the ratio of  $v_s/v_m$  and the factors to convert from  $D_w$  to  $k'$  for five EXC resins.

#### Converting $D_w$ to $k'$

Resin	$V_s/V_m$	To convert $D_w$ to $k'$ divide by
TEVA	0.23	1.9
UTEVA	0.25	1.7
TRU	0.22	1.8
Actinide	0.20	1.9
Sr	0.22	2.0

### Achievement of Separation

To achieve separation in EXC, band spreading must be sufficiently small to avoid early breakthrough and to avoid excessive cross-contamination of the constituents that one is trying to separate. Even if the extractants comprising the stationary phase exhibit very high selectivity for one of the ions, poor column efficiency, as manifested in excessive band spreading, can result in essentially no practical separation.

Column efficiency is generally expressed in terms of the height equivalent to a theoretical plate. Plate height is a complex function of a number of physical and chemical factors.

In EXC systems, column efficiency is determined primarily by flow phenomena, diffusion in the stationary phase and extraction kinetics.

The relative importance of each of these three factors to column efficiency depends on the specific chemical system, the particle size and porosity of the support, the extractant loading and mobile phase velocity and the operating temperature.



### Achievement of Selectivity

The EXC resins listed cover a wide range of selectivities and enable one to perform a number of novel highly efficient separations of selected fission products and individual actinides or groups of actinides. The following pages show the acid dependencies for the uptake, as measured by  $k'$ , of selected actinides and non-actinides on numerous resins of varying selectivity. Table 2 summarizes the important properties of some of these resins.

#### Properties of EXC Resins

Particle size ( $\mu\text{m}$ ) 100-150, 50-100  
 Bed density (g/mL) 0.33 to 0.39  
 Free column value (% bed volume) 65 to 69

Working capacity*	(mg/ml of Bed)
TEVA	15 (Pu)
UTEVA	32 (U)
TRU	4.5 (Am)
Sr	6.5 (Sr), 12 (Pb)
Ln	11 (Nd)
Actinide	14 (Am), 8.6 (Nd)

\*50% of maximum capacity

By E. Philip Horwitz

# APPLICATIONS

## Environmental monitoring and Bioassay

TrisKem's extraction chromatographic resins allow the separation and determination of radionuclides (e.g. actinides and fission products) from bioassay samples and environmental matrices e.g. [soil](#), [sediment](#), [vegetation](#) and [seawater samples](#). Their use allows a rapid and precise determination of radionuclides in emergency and routine situations, as well as, combined with suitable sample preparation methods, to obtain very low detection limits through analysis of large volume samples.

## Geochemistry and Metals Separation

TrisKem's expertise in separations and its variety of different resins with varying selectivities provides a number of opportunities to solve analytical problems through sample preparation. With our broad offer of products and long experience, TrisKem can help you meet lower detection limits with less uncertainty. The problems encountered are frequently centered on removing matrix that interferes with the instrumental measurement. ICP-MS is an example. Isobaric interferences often have to be removed in order to allow accurate determination of your analytes. Selectivity for the analyte of interest is important in these cases. Extraction chromatography is already widely used in various applications including [geochronology](#), [isotope ratio determination](#) and [provenancing](#).

## Decommissioning

The high selectivity of our resins not only allows the analysis of standard alpha and beta emitters (actinides, Sr-89/90, Ni-63, Tc-99,...) from high matrix samples including concrete, spent resin, but also the determination of so called difficult-to-measure (DTM) radionuclides such as [Sn-121m/Sn-126](#), [Zr-93](#),...

We are constantly working on developing new methods according to your needs. Methods for the following radionuclides are currently under development: [Se-79](#), [Sb-125](#), [Cs-135](#), [Nb-93m/Nb-94](#), [Ag-108m](#), [Pd-107](#), ...

## Radiopharmacy

TrisKem manufactures selective resins for [Lanthanides](#), [Sr](#), [Cu](#), [Zr](#), [Ac](#), [In](#), [Sc](#), [Ga](#) and many other radionuclides for medical purposes. We develop rapid, highly specific separation techniques for:

- Separation of radionuclides from irradiated targets
- Quality control of radionuclides for medical use
- Post-generator purification
- Radioprotection and Radioanalysis

# EXTRACTION CHROMATOGRAPHIC RESINS

## UTEVA Resin

UTEVA Resin (Uranium und TEtraValents Actinides), is used for the separation of Uranium and tetravalent actinides like Np, Th and Pu. The extractant coated on the inert support is the DP[PP] (Dipentyl pentylphosphonate) which shows an affinity for U(VI), Th(IV), Np(IV) and Pu(IV) over commonly occurring constituents such as Al, Fe, alkali and alkaline earth ions.

It's robustness against interference from common matrix elements greatly facilitates e.g. the analysis of U in small soil samples by alpha spectrometry, the completely digested sample can be directly separated on UTEVA resin after dissolution in 3M HNO<sub>3</sub>/ 1M Al(NO<sub>3</sub>)<sub>3</sub>.



Depending on the radionuclides to be measured, UTEVA Resin may be used alone or in combination with other resins. Combined with TRU Resin, UTEVA Resin is commonly used to sequentially separate U, Pu and Am.

UTEVA Resin is also frequently used for the separation of Zr from various matrices.

Ready-to-use methods available at: [www.triskem.com](http://www.triskem.com)

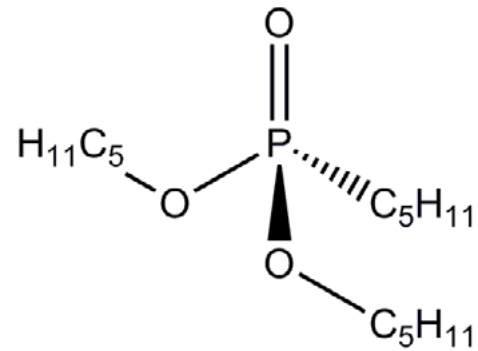

Dipentyl pentylphosphonate (DP[PP]) also called Diamyl amylphosphonate (DAAP)

Acid dependency of  $k'$  for various ions at 23-25°C.  
UTEVA Resin

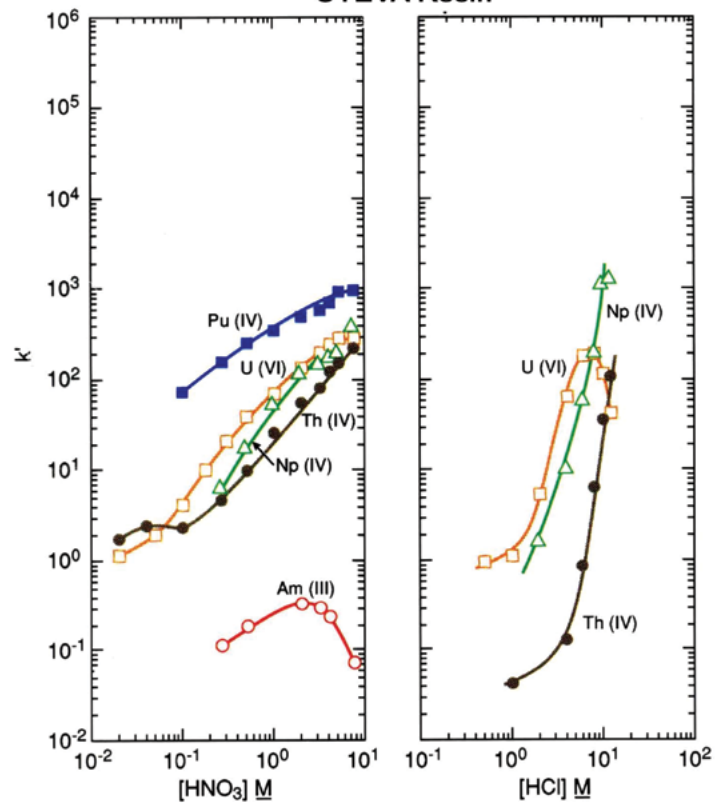

$k'$  values, UTEVA Resin, various elements, HNO<sub>3</sub> and HCl.

**Main applications:**

- U in soil, water and urine samples
- Actinides in soil, water and urine samples
- Separation of Zr



# TRU Resin

The stationary phase of TRU (TRans Uranium elements) Resin consists of a mixture of a carbamoyl-methylphosphine oxide (CMPO) and tri-n-butyl phosphate (TBP).

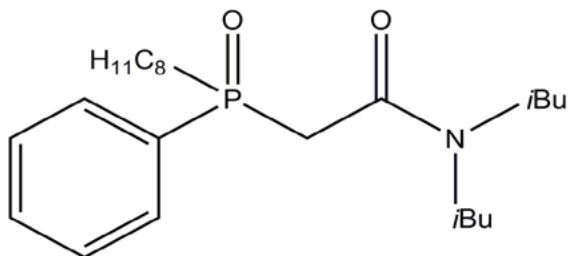

CMPO

Fe(III) shows no affinity for the resin in the range of 0.05 - 2M HNO<sub>3</sub>. Above 2M HNO<sub>3</sub> Fe(III) affinity is increasing with the HNO<sub>3</sub> concentration. TRU Resin properties towards Fe can be used for the separation and measurement of Fe-55.

The TRU Resin has further been used for the concentration of lanthanide groups and the removal of matrix elements upfront to their separation on LN Resin. Burnett et al. used the TRU resin in combination with anion exchange for the purification of Pa.

Ready-to-use methods available on our website:  
[www.triskem.com](http://www.triskem.com)

TRU Resin is used for the extraction and separation of tetra- and hexavalent actinides and, other than TEVA and UTEVA, also Am(III). Similar to UTEVA and TEVA Resins, TRU Resin allows by adjusting acid and acid concentration separating the actinides from matrix elements and each other.



**Main applications:**

- Actinides in soil, water and urine samples
- Fe-55 in water samples

Acid dependency of k' for various ions at 23-25°C. TRU Resin

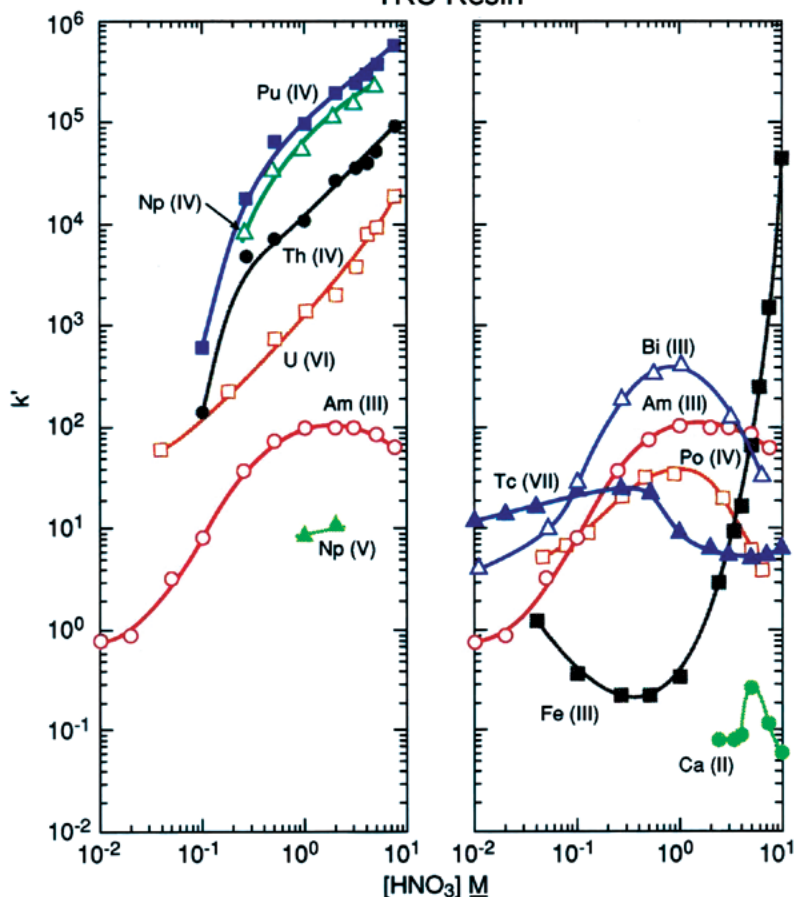

Acid dependency of k' for various ions at 23°C. TRU Resin

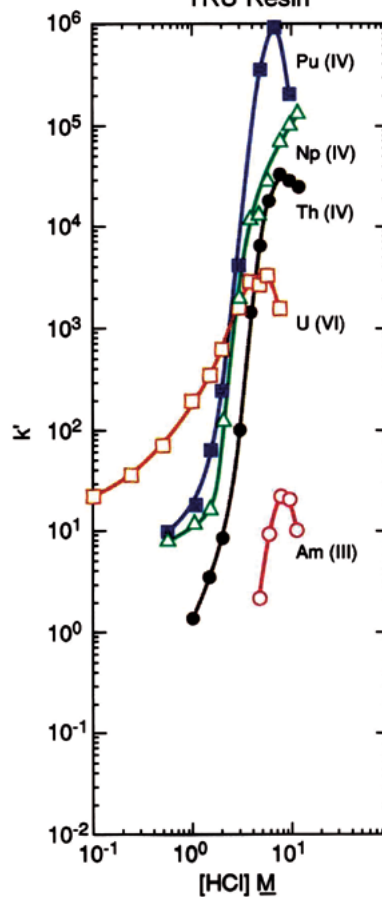

Elution profiles of different elements in HNO<sub>3</sub> and HCl media on TRU Resin

## TEVA Resin

TEVA Resin is mainly used to separate TEtraValent Actinides and technetium. The extractant that gives it its selectivity to the TEVA Resin is Aliquat® 336 a quaternary ammonium salt.  $k'$  values of various radionuclides in  $\text{HNO}_3$  and  $\text{HCl}$  are presented in figure hereafter. Differences in  $k'$  values between  $\text{HNO}_3$  and  $\text{HCl}$  media may be used to separate Th, Np and Pu from the other actinides.

Pu(IV), Np(IV) and Th(IV) show maximum retention in 2-4M  $\text{HNO}_3$ . In this acidity range, Am(III) and U(VI) are not fixed.

$k'$  differences between  $\text{HNO}_3$  and  $\text{HCl}$  media may be used to separate Th from the other actinides. When the sample is loaded on the resin from 4M  $\text{HNO}_3$ , Pu(IV), Th(IV) and Np(IV) are retained. Th may then be eluted with 6M  $\text{HCl}$  while Pu(IV) and Np(IV) remain on the resin in these conditions.

Pu might be stripped out of the resin with 4M  $\text{HNO}_3$  or 8M  $\text{HCl}$ , after having reduced its oxidation state from +IV to +III.

Under specific conditions, Am may be fixed on the TEVA Resin and separated from light lanthanides. In 1-2M  $\text{NH}_4\text{SCN} - 0.1\text{M HCO}_2\text{H}$ , Am is fixed on the resin while La and Eu are eluted. Am is then stripped from of the resin with 0.25M  $\text{HCl}$ .

Further to actinide separations TEVA Resin is also used to separate Tc and Re from various sample matrixes.

TEVA Resin is also available in form of discs allowing for the rapid analysis of Tc-99 in aqueous samples

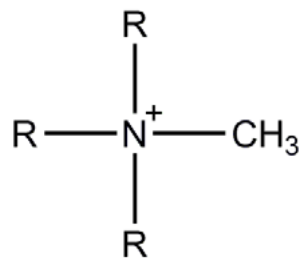

Quaternary ammonium salt Aliquat® 336,  
R = octyl or decyl

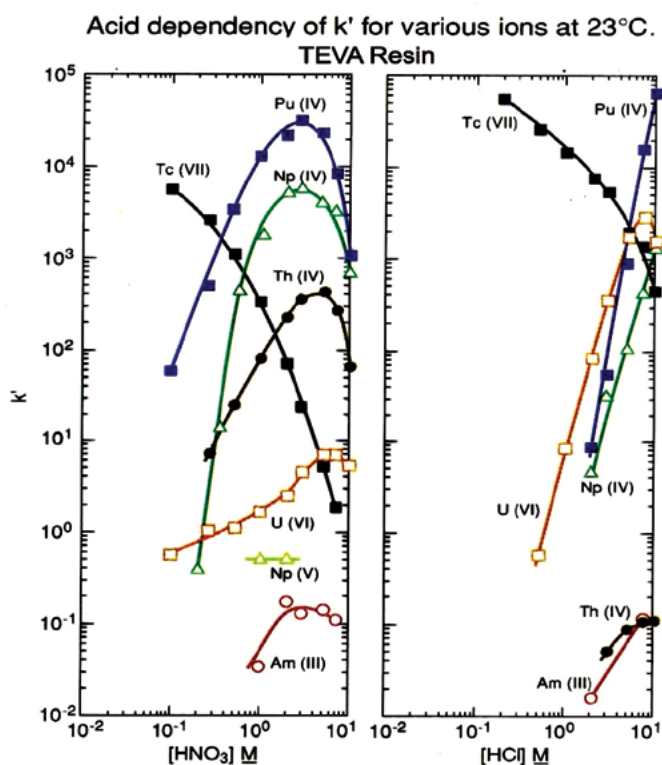

$k'$  values, TEVA Resin, various elements,  $\text{HNO}_3$  and  $\text{HCl}$



**Main applications:**

- Actinides in soil, water and urine samples
- Tc-99 in water and urine samples
- Am/LN separation

Ready-to-use methods available at: [www.triskem.com](http://www.triskem.com)

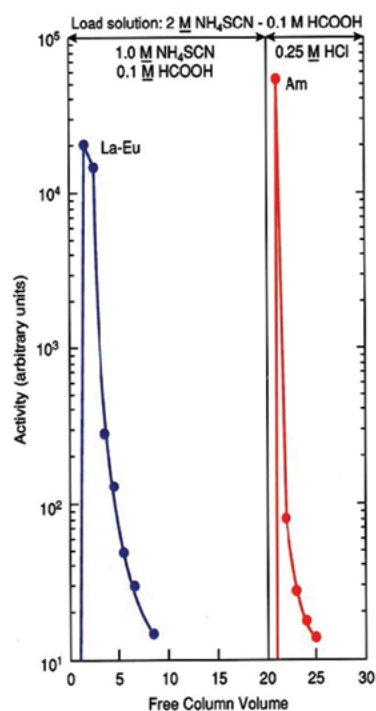

Separation of La-Eu and Am on TEVA resin

## SR Resin

Sr Resin is based on the principle of ionic recognition. The stationary phase consists of a dicyclohexano 18-crown-6 derivative dissolved in octanol.

The data in the following figures shows that the uptake of Sr is greater than the uptake of other alkali and alkaline earth ions and most other cations tested.

The selectivity for Sr over Ca is particularly noteworthy because Ca is a major constituent in many samples. Pb is even stronger retained on the Sr Resin, allowing for a facile elution of Sr from the resin using dilute  $\text{HNO}_3$ , leaving Pb retained.

Potassium shows very small affinity for the resin. However, if its concentration is larger than 0.01M, which is often the case in soil, vegetables and other environmental matrices, it affects the strontium uptake. In these cases, it is advisable to perform an earth alkaline oxalate precipitation to eliminate potassium, prior to the load.

The high selectivity of the SR Resin for Pb makes its elution from the resin more complicated, which is why the Pb Resin has been developed.

Sr Resin typically finds application in the determination of Sr-89/90 and Pb-210/Po-210 in biological and environmental samples, as well as in the determination of Sr and Pb isotopic ratios by mass spectrometry and in radionuclide production.

Ready-to-use methods available at: [www.triskem.com](http://www.triskem.com)

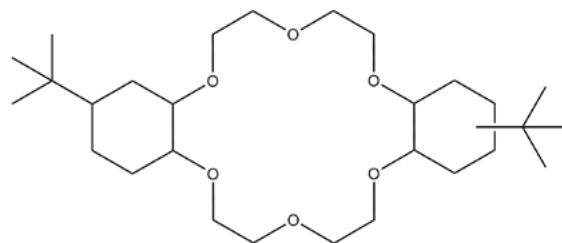

4,4'-(5'-di-t-butylcyclohexano-18-crown-6)

Acid dependency of  $k'$  for various ions at 23-25°C.

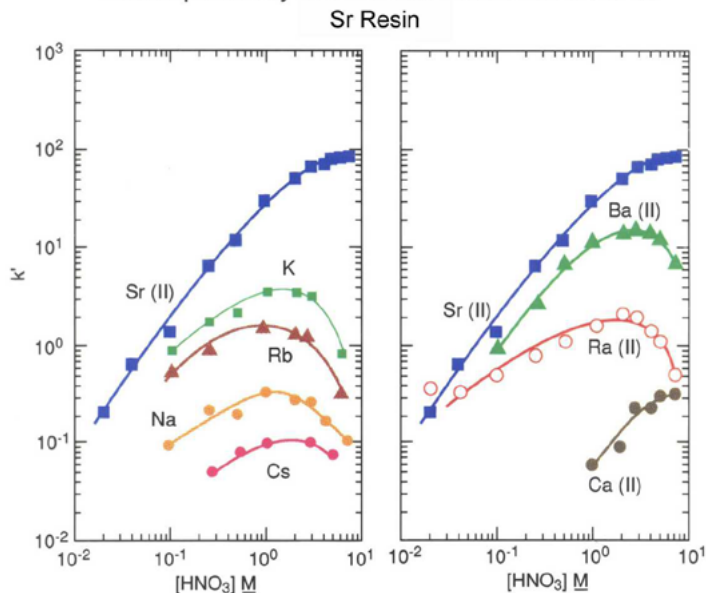

Acid dependency of  $k'$  for various ions at 23-25°C.

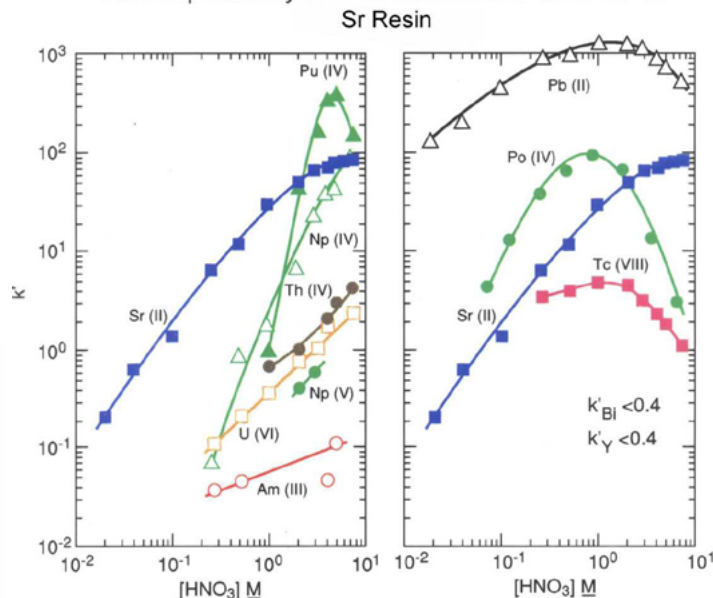

Acid dependencies of uptake of selected metal ions by Sr Resin

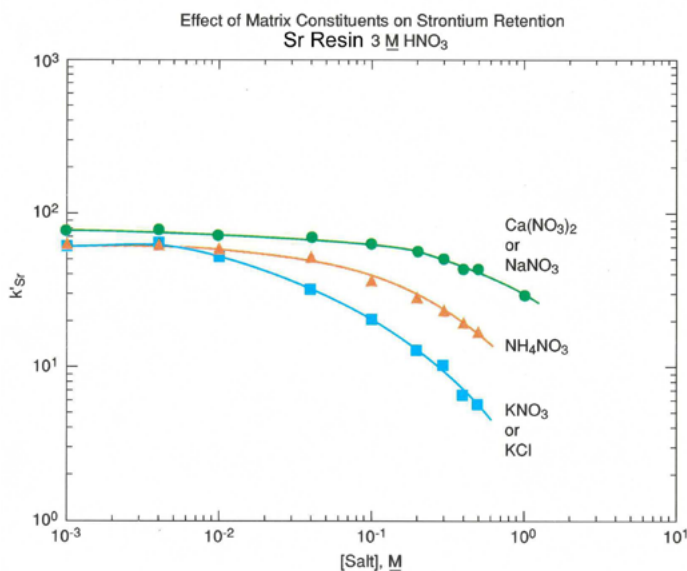

Interference of different elements on strontium uptake

**Main applications**

- Sr-89/90 in soil, food, water and environmental samples
- Sr and Pb isotope ratios
- Pb-210 in soil samples
- Pb-210 and Po-210 in food, water and environmental samples

Determination of Sr-89/90 in water samples, modified version of Eichrom method SRW01-14

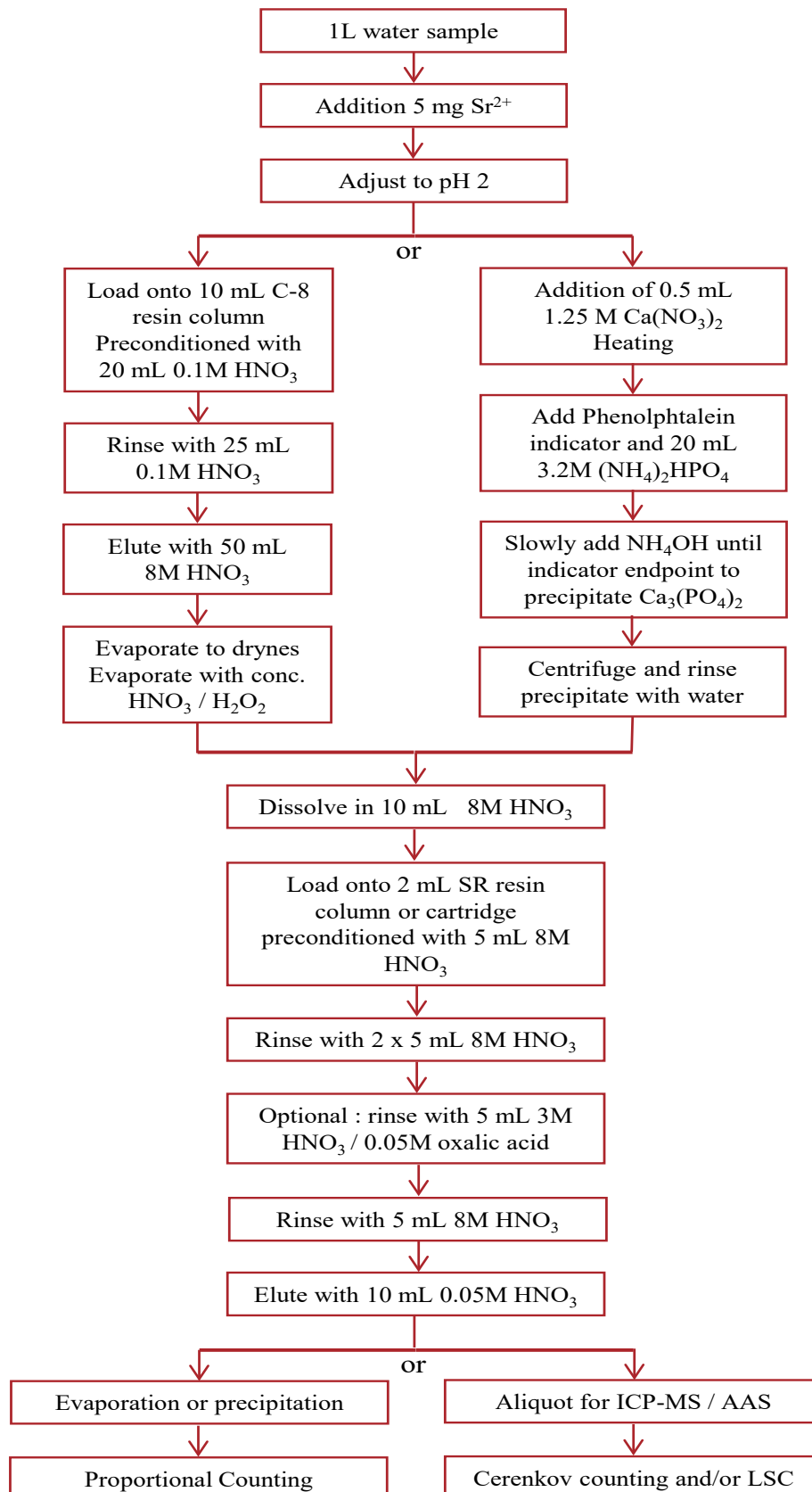

# Pb Resin

Lead Resin (PB Resin) is composed of the same crown-ether used in the SR Resin, isodecanol is used as diluent though.

The isodecanol, having a longer carbonated chain than n-octanol, is used to facilitate lead elution from the resin.

The Pb Resin has a very similar selectivity than the Sr Resin, but  $k'$  values are in general lower, allowing for simpler Pb elution. Pb Resin is typically used for the determination of Pb-210 in water samples.

Lead affinity ( $k'_{Pb}$ ) for Pb Resin over the range  $10E-02$  to  $10E+01$  M  $HNO_3$  is varying from  $\sim 20$  to 800. In HCl media,  $k'_{Pb}$  for Pb Resin varies from 20 to 100. The maximum retention is observed between  $5.10E-02$  to 2 M HCl. Below and above these HCl concentrations, Pb affinity for the resin is rapidly decreasing.

Monovalent and divalent ions show similar  $k'$  values as those observed on Sr Resin.

Sodium and calcium do not interfere with the lead uptake on the Pb Resin for concentrations from  $10E-02$  to 1 M.

The presence of potassium up to 1M still allows a lead uptake with  $k'_{Pb} \sim 80$ .

Elution of lead can be performed with different solutions as 0.1M or 0.05M ammonium citrate, dilute citric acid, 0.1M ammonium tartrate or water.



**Main applications:**

- Pb-210 in water samples

Ready-to-use methods PBW01 Lead-210 and Polonium-210 in Water PBS01 Lead in Soil... available at: [www.triskem.com](http://www.triskem.com)

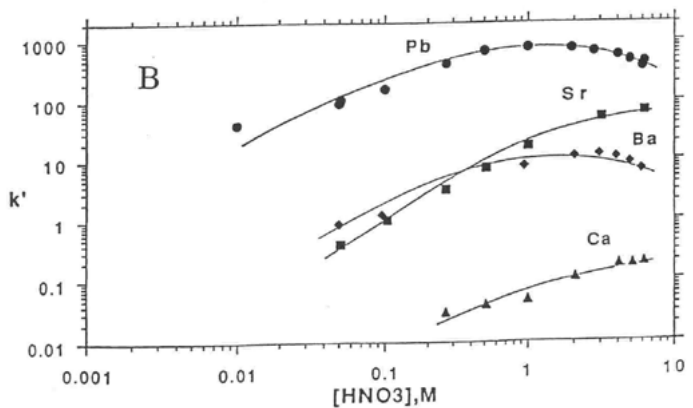
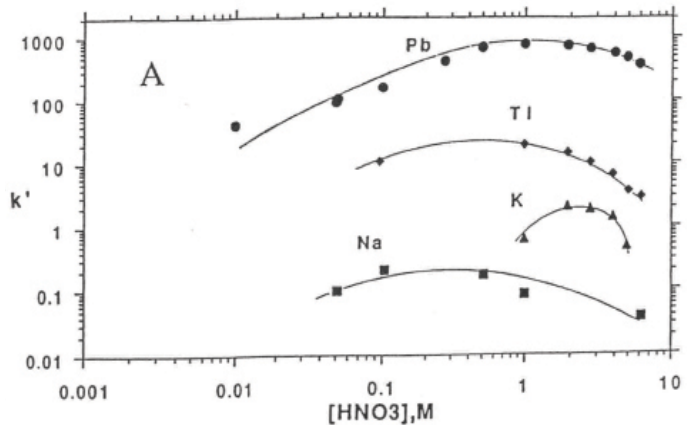
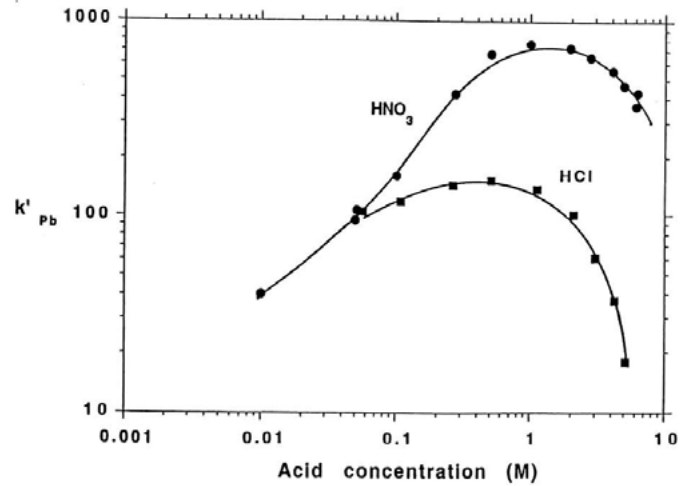

Acid dependencies of the uptake of selected metal ions by Pb Resin

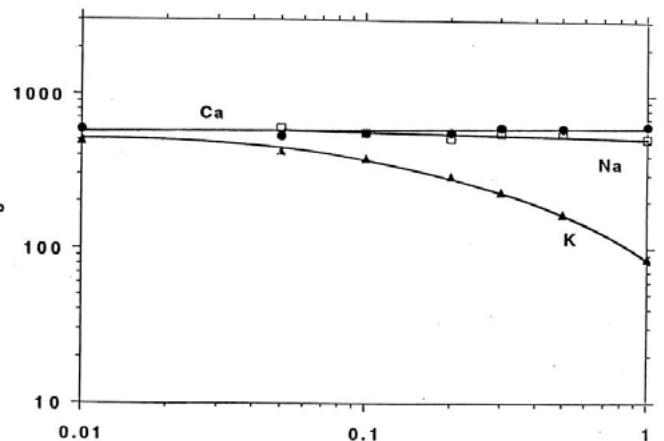

Influence of interfering ions on  $k'_{Pb}$  on Pb Resin in  $HNO_3$  media

# DGA Resins

DGA Resin is an extraction chromatographic resin based on either N,N,N',N'-tetra-n-octyldiglycolamide (DGA, Normal resin, abbreviated DN Resin, TODGA in literature) or N,N,N',N'-tetrakis-2-ethylhexyldiglycolamide (DGA, Branched Resin, abbreviated DB Resin, TEHDGA in literature) extractant.

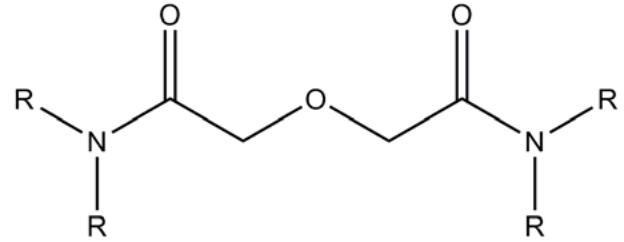

DGA resin extractant, R = octyl or ethylhexyl

The following figure compares the  $k'$  values for Am(III) obtained on a number of extraction chromatographic resins. As it can be seen the DGAs Resins show very high  $k'$  at high acid concentrations, whereas it can easily be eluted with dilute acid solutions. It compares  $k'$  values of selected actinides on normal and branched DGA Resins.

This combined with DGAs stability against interfering elements like Al(III), Fe(III) or Ti(IV) makes it an interesting tool for the determination of Am in environmental samples, for example in sequential separation methods for the determination of actinides in large soil or food samples.

Horwitz et al. showed that cations that are forming

very large and soft chloro-anions (e.g.  $\text{FeCl}_4^-$ ) strongly increase Am retention on DGA. This effect can be used to concentrate Am (together with other actinides) from elevated volumes of soil sample (100g) leachates while most matrix elements pass the DGA Resins without being retained.

It also was shown that DGA can successfully be used for actinium separation, in environmental applications e.g. in the determination of Ra-228 as well as in the field of radiopharmaceuticals, for example in the separation of Ac-225 for the preparation of Bi-213.

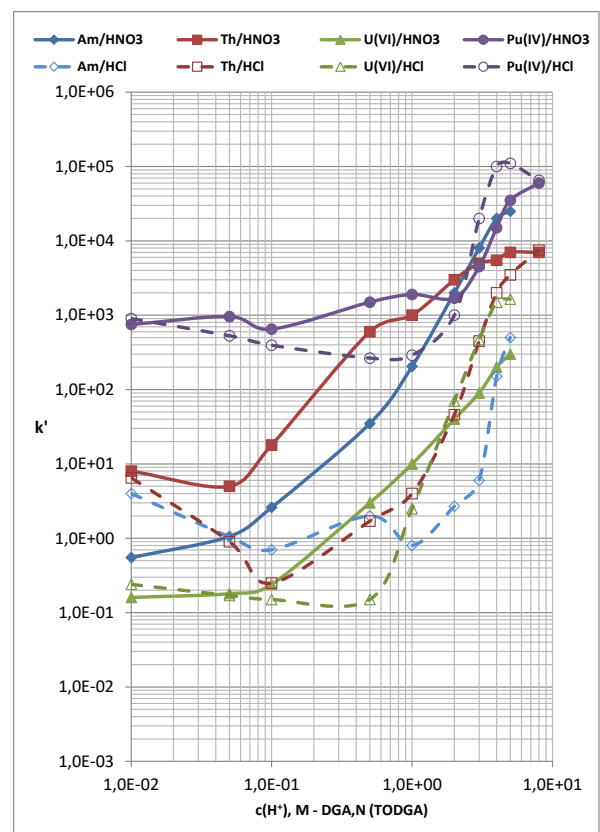
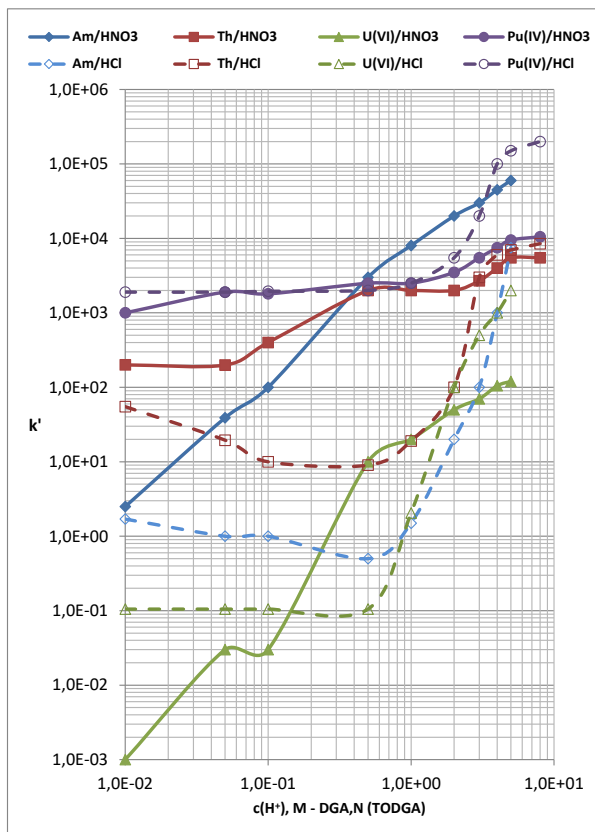

Comparison of  $k'$  values of different actinides on DGA Resins

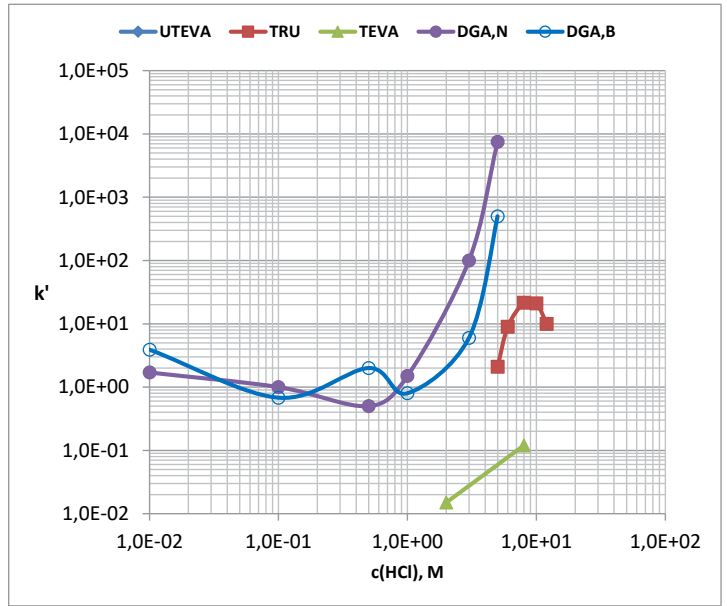
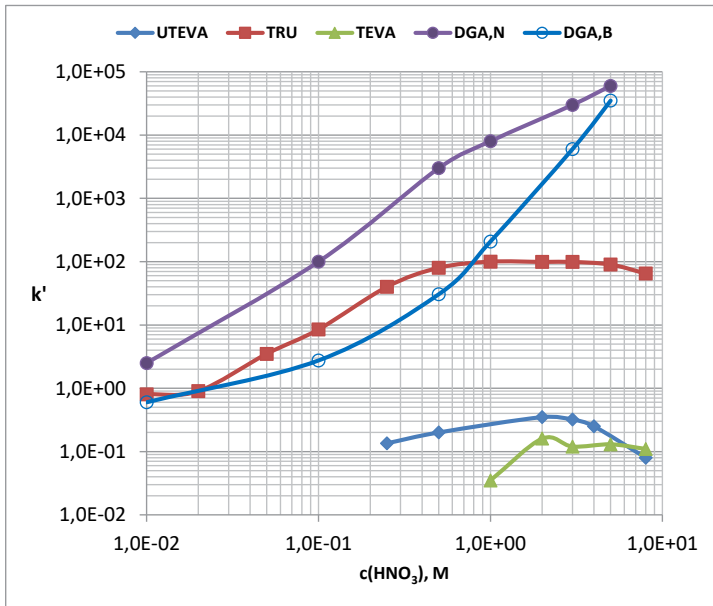

Comparison of Am  $k'$  values on different extraction chromatographic resins

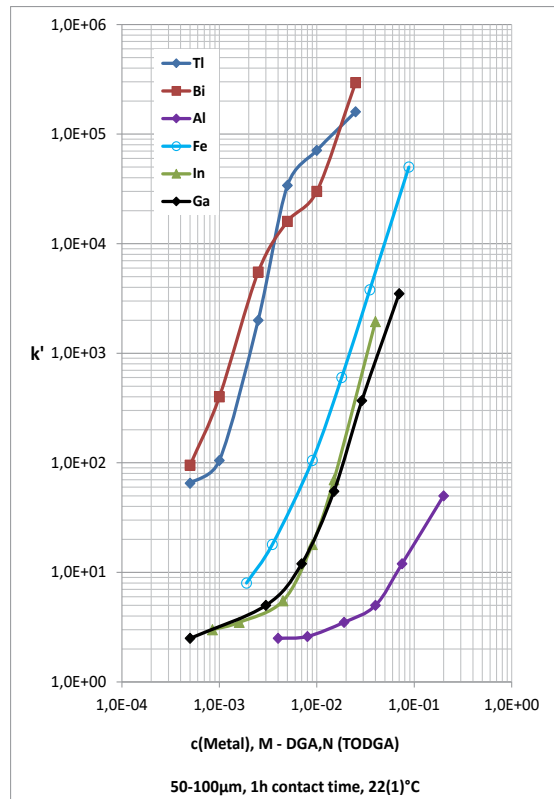
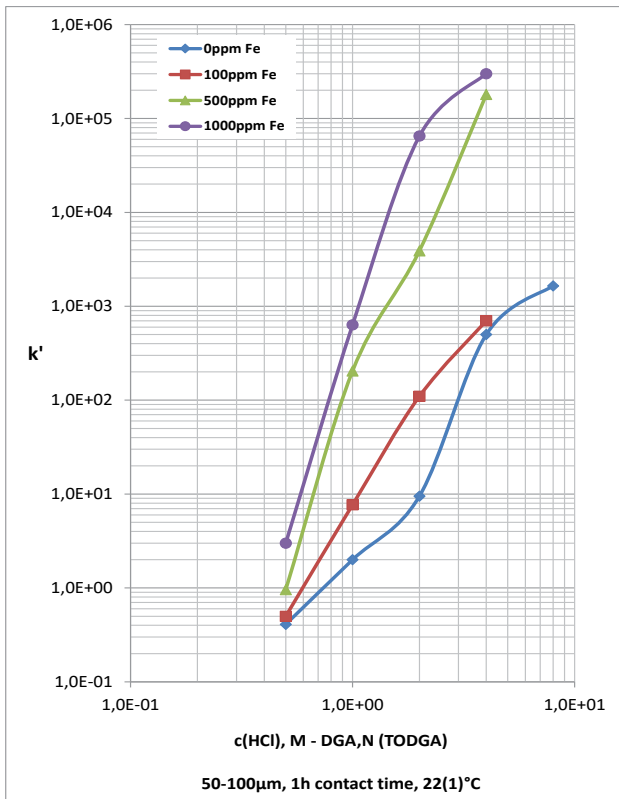

$k'$  values for varying metal and HCl concentrations on Normal DGA

Ready-to-use methods at:  
[www.triskem.com](http://www.triskem.com)



**Main applications :**

- Preconcentration of actinides from large soil and environmental samples
- Determination of Am in large soil and food samples
- Separation of Ac-225
- Determination of Ra-228

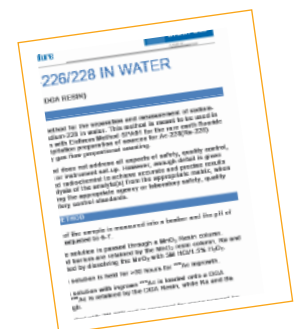

# DGA Sheets

A DGA impregnated chromatographic paper

Radionuclide separation and radionuclidic purity determination was never easier. Separation of generator isotopes and radionuclide mixtures on DGA impregnated chromatographic paper, which has been developed at the CVUT, including mixtures like Ac-227, Th-227, Ra-223, Sr-90/Y-90, Ge-68/Ga-68, Mo-99/Tc-99m, Pb-212 and Ac-225/Bi-213 is now possible using one separation material, just by changing the composition of the mobile phase (diluted mineral acids like 1M HNO<sub>3</sub> or HCl). The chromatographic paper is available impregnated with DGA with variable active compound loading (0.1-10%).

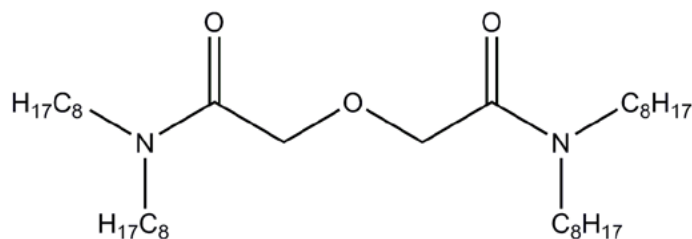

The method is easy to validate and TLC scanners or alternatively, after cutting the paper, common radiometers may be used to determine radionuclidic purity of a generator eluate or a purified radionuclide product.

Proposed standard sheet dimensions are 5 x 20 cm, 10 x 10 cm and 20 x 20 cm. Other selectivities/extractants, formats and custom dimensions are also available upon request.

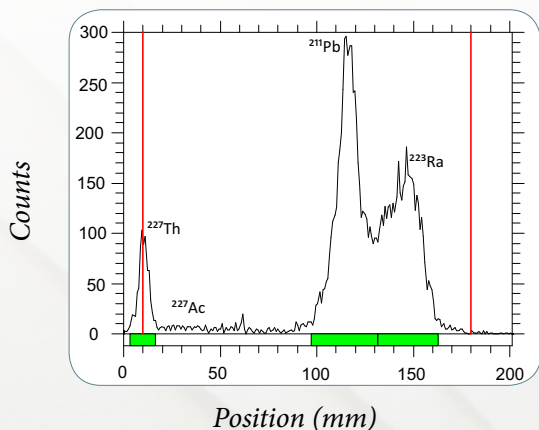

Radiochromatogram measured immediately after separation

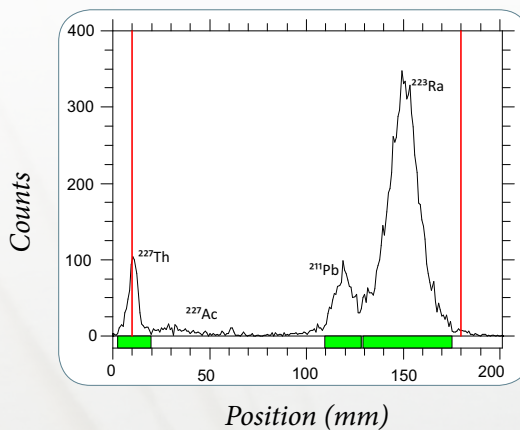

Radiochromatogram measured one hour after separation

Start

Front

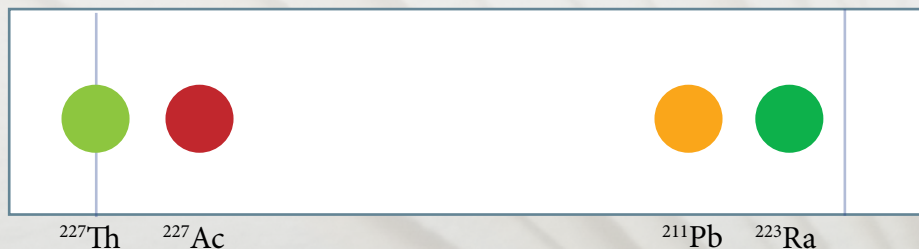

Scheme of a chromatographic separation of a mixture of Ac-227 and its descendants. Th-227 remains on start, Ac-227 has a retention factor  $R_f$  of ca. 0.2, Pb-212 of ca. 0.7 and Ra-223 of ca. 0.9.



# LN Resin Series

The LN Resins contain dialkyl phosphoric (LN), phosphonic (LN2) or phosphinic (LN3) acids, the acidity of the impregnated extractants is diminishing in the order LN>LN2>LN3. This difference in acidity is having an impact on the retention behavior of the resins.

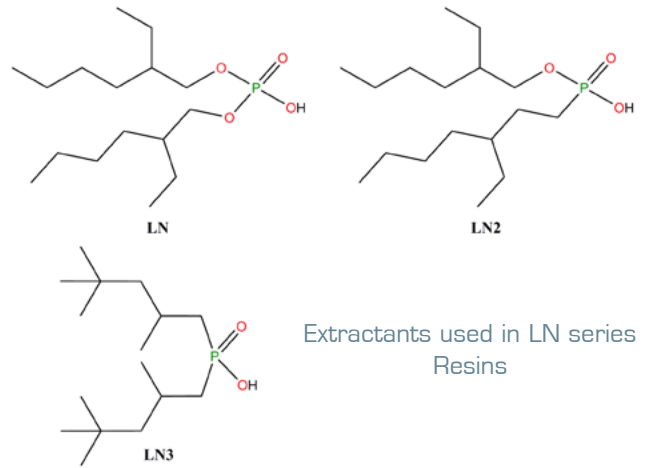

LN Resin finds application in methods for the determination of Ra-226 and Ra-228 in environmental samples and the separation of lanthanides. In the latter case it is frequently employed in combination with the RE resin which is used to concentrate the lanthanides, and to eliminate part of the matrix.

Besides the LN Resin, TrisKem also provides LN2 resin, which can be used for the separation of heavy lanthanides (e.g. separation of Lu-177 from irradiated Yb-176) and LN3 which is used in Lanthanide separation and the separation of Zn and Co.

The figure on the right compares the relative selectivity of the resins for lanthanide elements (normalized to  $k'_{La}/LN2=1$ )

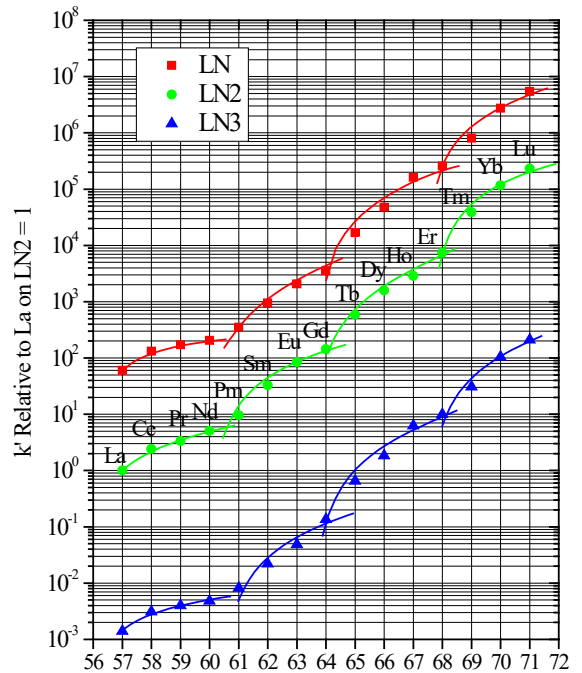

Relative  $k'$  values of lanthanides normalized to La retention on LN2 Resin ( $k'_{La}/LN2=1$ )

The figure hereafter summarizes the  $k'$  values of selected cations on all three resins.

**Main applications:**

- Ra-226 and Ra-228 in water samples
- Separation of lanthanides

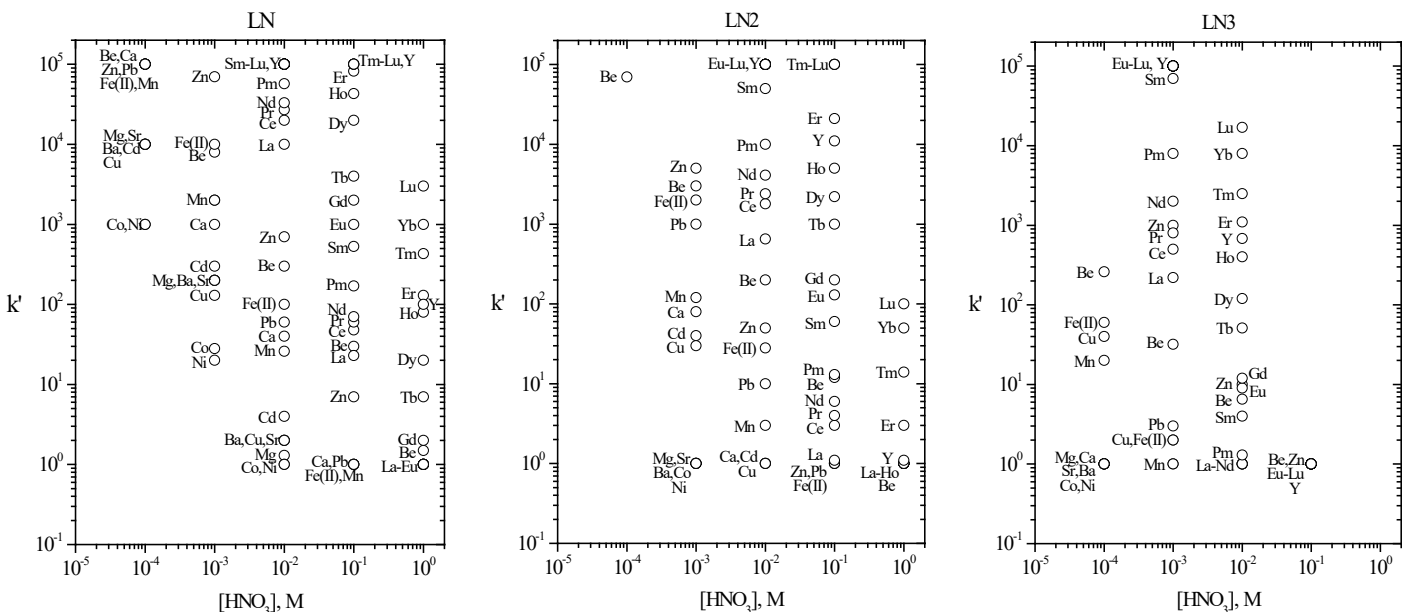

Capacity factor  $k'$  of various cations in  $HNO_3$  on LN / LN2 / LN3 Resins

## NI Resin

Nickel Resin consists of dimethylglyoxime (abbreviated DMG) coated on an inert support, and is dedicated to the separation of nickel from the other elements.

Unlike extraction chromatographic resins, it is based on an on-column precipitation of nickel with dimethylglyoxime at pH 8-9.

The pink  $\text{Ni}(\text{DMG})_2$  complex formed during precipitation is very stable and insoluble under these conditions, and is thus retained on the column.

The sample loading is performed in presence of ammonium citrate in order to keep elements such as Fe in solution. After rinsing with pH 8-9 ammonium citrate solution in order to remove matrix elements and interferences Ni can be eluted from the column using 3M  $\text{HNO}_3$ . The following table shows typically obtained decontamination factors.



**Main applications :**

- Ni-63 and Ni-59 separation in water, environmental and decommissioning samples

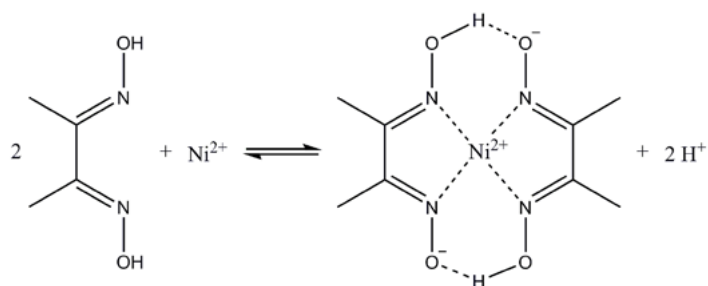

Precipitation of nickel cations with 2 molecules of dimethylglyoxime,  $\text{Ni}(\text{DMG})_2$ .

Decontamination factors obtained on NI Resin for different radionuclides:

Radionuclides	Decontamination factors
Cr-51	3.5E+02
Mn-54	8E+03
Fe-55	4E+0.2
Co-58	1E+03
Co-60	1.1E+03
Nb-95	1.3E+02
Cs-134	2.8E+03
Cs-137	3E+03

Ready-to-use methods available on our website:  
[www.triskem.com](http://www.triskem.com)

## RE Resin

The RE (Rare Earth) Resin, like the TRU Resin, is composed of CMPO dissolved in TBP and impregnated onto an inert support. In case of the RE resin the proportion of CMPO used is higher than for the TRU Resin, with the aim of increasing its affinity for the REEs.



The resin is mostly used for the separation of group Rare Earth Elements (REE), especially of the heavy REEs, mainly with respect to matrix elements. It is complementary to the LN Resin which is used for the actual separation of the lanthanide elements. RE Resin is further used for the separation and purification of Y isotopes, e.g. of Y-90 for medical use.



**Main applications :**

- RE in soil, water and environmental samples
- Y separation

## CL Resin

The CL Resin is based on an extraction system that is selective for platinum group elements (PGE), gold and silver and is mainly used for the separation of chloride and iodide, especially in the context of Cl-36 and I-129 analysis.

The selectivity for halides is introduced by loading the resin with  $\text{Ag}^+$  allowing good selectivity for anions, especially halides, forming sparingly soluble or insoluble  $\text{Ag}^+$  complexes. Since the resin retains  $\text{Ag}^+$  over a wide range of pH values it also allows loading chloride and iodide from various conditions (slightly alkaline to strongly acidic), ideally under reducing conditions to assure their presence as halides.

After loading and rinsing of the resin (removal of matrix elements and interferences), chloride can be easily eluted from the resin using dilute  $\text{SCN}^-$  solutions whereas iodide remains fixed. Iodide can then be eluted from the resin using a moderately concentrated  $\text{S}^{2-}$  solution.

This allowed Zulauf et al. developing a simple scheme for the separation of chloride and iodide. The small elution volumes (5 mL) used for elution allow for direct measurement of the obtained fractions by liquid scintillation counting.

Warwick et al. developed a method for the analysis of decommissioning samples (e.g. spent resin) based on the thermal decomposition of the sample to be analysed using a Raddec 'Pyrolyser' furnace (p.41). Volatilized chlorine species are transported by a stream of moistened air into a bubbler containing a 6 mM  $\text{Na}_2\text{CO}_3$  solution where they are trapped. The authors modified the separation procedure so that the bubbler solution could then directly be loaded onto a  $\text{Ag}^+$  loaded CL Resin column.

It was observed that, since the sample was not loaded from a highly acidic sample solution, an additional rinsing step consisting of 5 mL 0.1M  $\text{H}_2\text{SO}_4$  was necessary in order to improve C-14 decontamination.

Nottoli et al. employed the CL Resin for the determination of I-129 in spent resins by AMS. The authors first mineralized the resin via microwave digestion or by oxygen bomb combustion. Iodine was then purified on CL Resin using a modified purification method. Samples were prepared for AMS measurement by oxidation

of the sulphide to sulphate with  $\text{H}_2\text{O}_2$ , removal of the sulphate by precipitation with Ba followed by centrifugation, and finally a  $\text{AgI}$  precipitation.

With respect to its high selectivity for noble metals the CL Resin is currently being evaluated for use in Ag and PGE separation and determination.

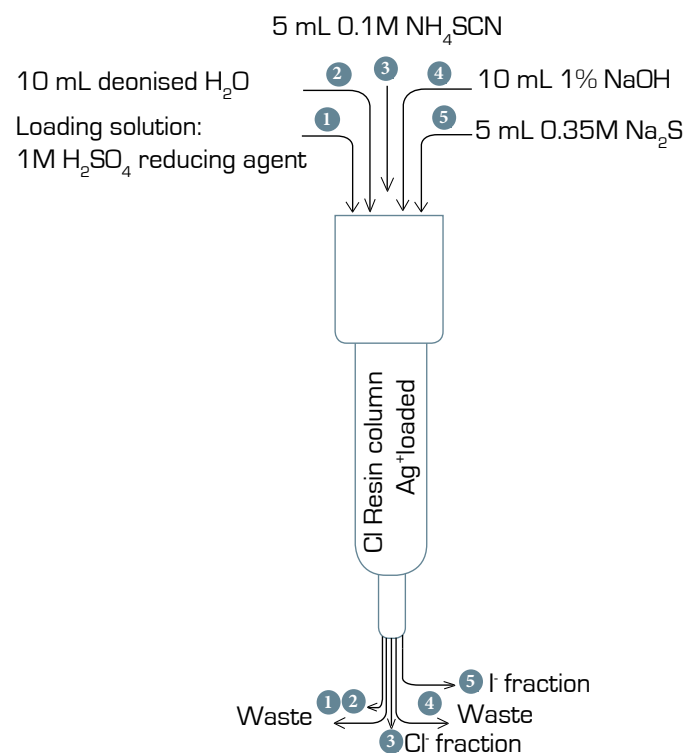

Scheme of chloride / iodide separation

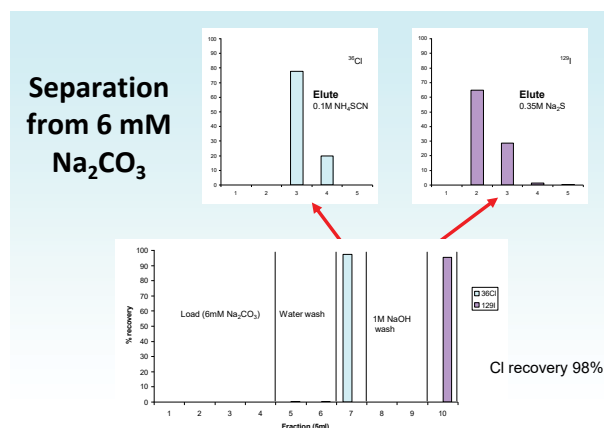

Scheme of chloride / iodide separation



### Main applications:

- Cl-36 and I-129 in water, environmental and decommissioning samples

# CU Resin

The CU Resin is used for the separation of Cu and is based on a Cu selective extraction system. The extraction behaviour of the CU Resin towards a number of elements in three different acids at varying acid concentrations is presented in the following figures.

Overall the resin shows high selectivity for Cu over all tested cations including Ni and Zn. Cu uptake is generally high at pH values greater than 2 while it can be easily eluted with mineral acids of elevated concentrations.

Further the resin shows high robustness against interference by elevated amounts of Zn and Ni, even at 1g of Ni or Zn per g of CU Resin employed the  $D_w(\text{Cu})$  remains greater than 1000.

A simple and fast method for the separation of Cu from irradiated targets was developed by Dirks. et al. allowing to obtain highly pure Cu in a very small volume (1 - 1.5 mL) in less then 10 min using a vacuum assisted separation setup.

It further could be shown that Cu can be concentrated and separated from other high-matrix samples such as sea water.

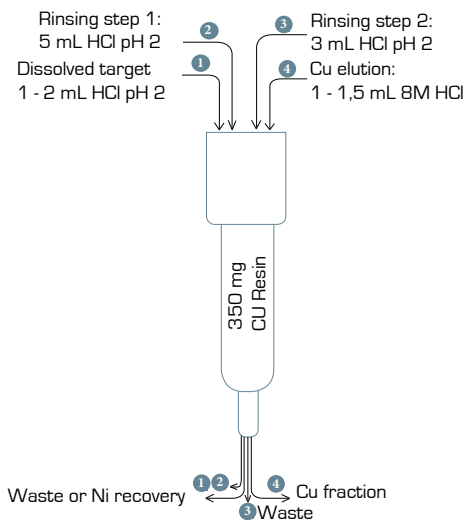

Optimized Cu separation method

**Main applications:**

- Separation of Cu-64/67 from irradiated targets
- Concentration and separation of Cu from environmental matrices
- Purification of target materials

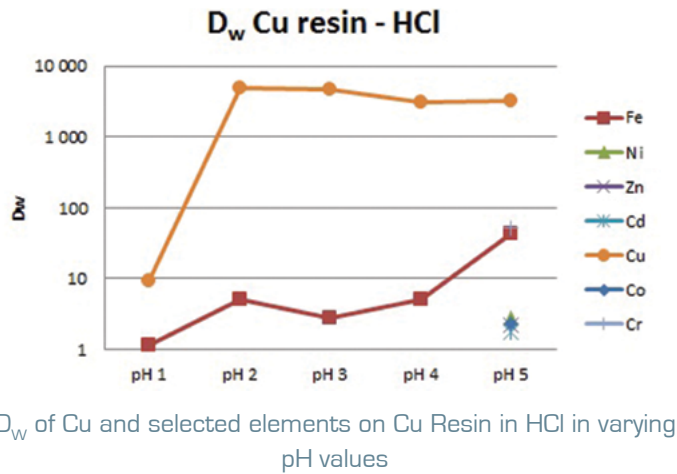

$D_w$  of Cu and selected elements on Cu Resin in HCl in varying pH values

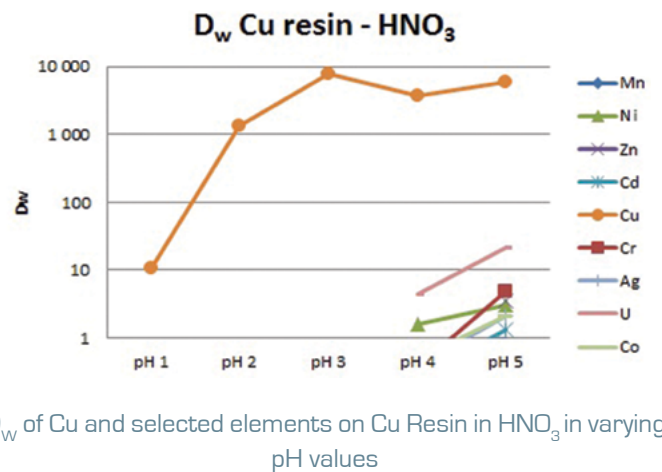

$D_w$  of Cu and selected elements on Cu Resin in HNO<sub>3</sub> in varying pH values

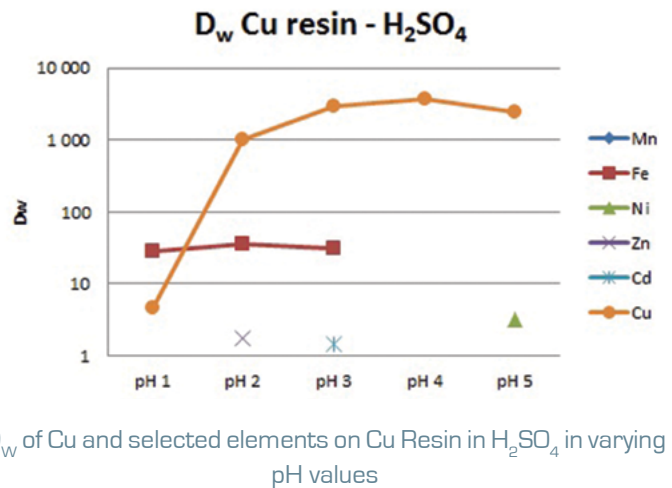

$D_w$  of Cu and selected elements on Cu Resin in H<sub>2</sub>SO<sub>4</sub> in varying pH values

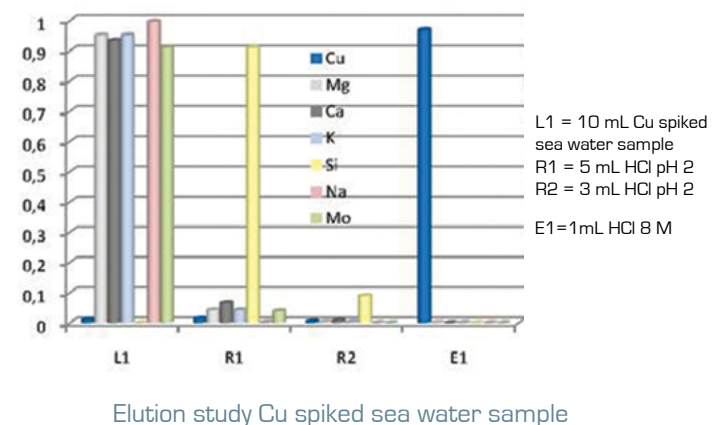

Elution study Cu spiked sea water sample

## ZR Resin

The ZR Resin is based on the hydroxamate functionality frequently used for the separation of Zr, especially from Y target materials for later use in radiopharmaceutical applications. Dirks et al.<sup>[1]</sup> characterized the resin with respect to its selectivity for selected elements in HNO<sub>3</sub>, HCl and oxalic acid, some results are shown in the figures hereunder.

The ZR Resin shows high selectivity for Zr, Ti and Nb over a wide range of HCl concentrations (0.01M – 10M), Fe(III) is strongly retained at low and elevated HCl concentrations, retention is weaker from 1 – 6M HCl. As expected the resin shows very little selectivity for Sc and Y, a separation of e.g. Zr from Y and Ti from Sc is thus possible.

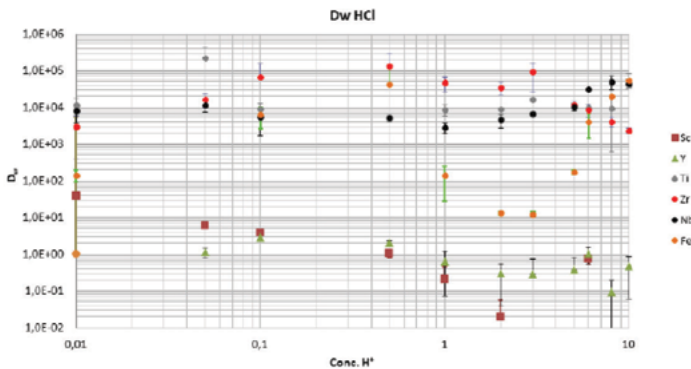

D<sub>W</sub> values, ZR Resin, HCl, various elements

The resin shows rather similar selectivity in HNO<sub>3</sub>, Zr, Ti and Nb are well retained up to 5M HNO<sub>3</sub>, Fe(III) is well retained up to 1M HNO<sub>3</sub>. At higher HNO<sub>3</sub> concentrations the nitric acid starts attacking the extractant, indicated by a colour change of the resin from white to brown; accordingly the resin shows no significant selectivity towards the tested cations under these conditions. As in HCl, Y and Sc show no significant retention on the ZR Resin in HNO<sub>3</sub>.

Oxalates are very strong complexing agents for Zr, accordingly they are very frequently used for the elution of Zr.

It could be shown that oxalic acid concentrations above 0.05M lower the D<sub>W</sub> value of Zr on the ZR Resin strongly; they are thus suitable eluting agents for Zr. It was further observed that Nb shows high D<sub>W</sub> values even at 0.05M oxalic acid, Zr and Nb may thus be separated by adjusting the oxalic acid concentration accordingly.

Zr can be recovered near quantitatively in 1.5 mL dilute oxalic acid even in presence of up to 300 mg stable Y (using a 100 mg ZR Resin column).

The loading is preferably performed under reducing conditions in order to remove Fe from the column before Zr elution. The following shows schematically the optimized separation conditions

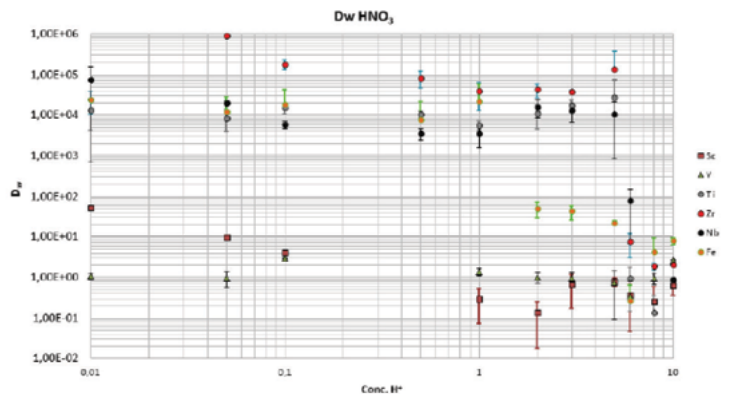

D<sub>W</sub> values, ZR Resin, HNO<sub>3</sub>, various elements

Other than for Zr the ZR Resin also shows very interesting selectivity for Ti, especially with respect to Sc. While Sc is not retained e.g. from 10 M HCl Ti is fixed very well. 0.1M citric acid may then be used to elute Ti from the resin; beside citric acid, hydrogen peroxide, oxalic acid of elevated or HNO<sub>3</sub> of high concentration may be employed.

As Ti is retained over a very wide range of HCl concentrations, including dilute HCl, its potential for use as support for a Ti/Sc generator is currently evaluated.

Other than for Zr, Nb, Ga and Ti the resin also shows very interesting selectivity for Ge over Ga, allowing for its separation from macro quantities of Ga.

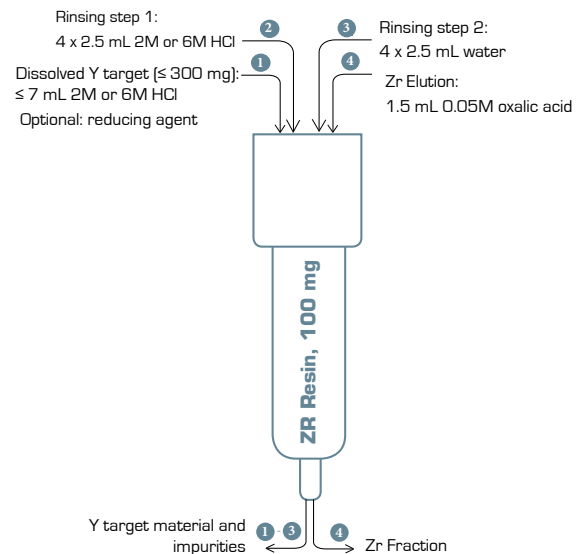

Suggested method for the separation of Zr from Y targets (≤ 300 mg) using the ZR Resin



### Main applications:

- Separation of zirconium
- Separation of titanium
- Separation of germanium
- Separation of gallium

# TBP Resin

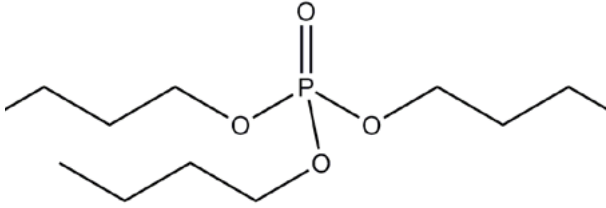

TriButylPhosphate [TBP]

The TBP Resin is comprised of an inert support impregnated with Tributylphosphate (TBP). TBP is a widely used extractant, it finds for example application in the Purex process, the reprocessing of U and Pu from spent fuel. Other applications include, amongst others, the separation of yttrium for analytical purpose.

The following figure shows the  $D_w$  values of selected actinides on the TBP Resin in  $HNO_3$  and HCl.

Vajda et al. also evaluated the influence of Fe(III) and three anionic interferences (oxalic, sulfuric and phosphoric acid) on the U and Pu uptake.

In 8M  $HNO_3$  a Fe concentration of 0.1M is not interfering with the uptake of U(VI) and Pu(IV), the same is true for Np(IV) and Th(IV). Unlike this,

the same Fe concentration very strongly interferes with the retention of U and Pu in 9M HCl.

Oxalates show no interference with the U uptake even at concentrations of up to 0.5M. Sulfate, and especially phosphate, interfere significantly when present in elevated amounts. In general the actinides show an increasing retention at increasing acid concentrations.

However, of all actinides only Pu shows  $D_w$  values higher than 100 in  $HNO_3$ , whereas the other actinides peak at  $D_w$  values between 60 and 80. Pu is even stronger retained at high HCl concentrations ( $D_w > 1000$  on 9M HCl), retention of the other actinides, with exception of Np in 9M HCl ( $D_w = 140$ ) is rather low, especially Th(IV) shows very little affinity to the TBP Resin.

Nora Vajda et al. could show that the TBP Resin can be used for the separation of Pu from other actinides and developed a method for its use for the determination of Pu in water samples.

The Pu(IV) extraction from 9M HCl is very robust, although the tested anions do interfere with its uptake when present in concentrations  $\geq 0.1M$ , the  $D_w$  values of Pu still remain greater than 500.

Weight distribution ratios of actinides on TBP resin

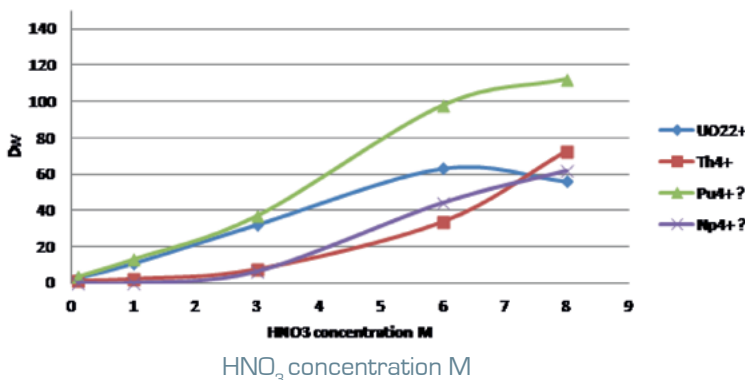

Weight distribution ratios of actinides on TBP resin

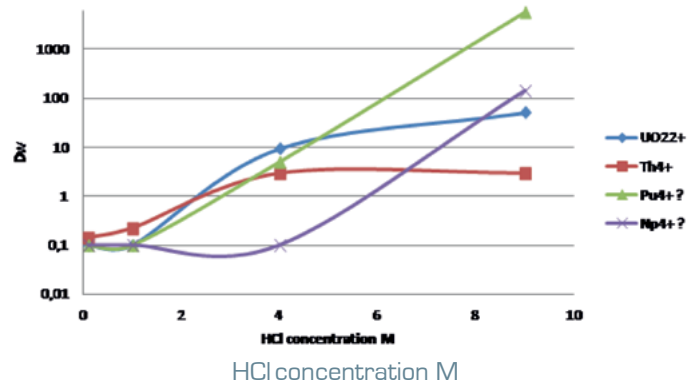

$D_w$  values of selected actinides in  $HNO_3$  and HCl media on TBP Resin

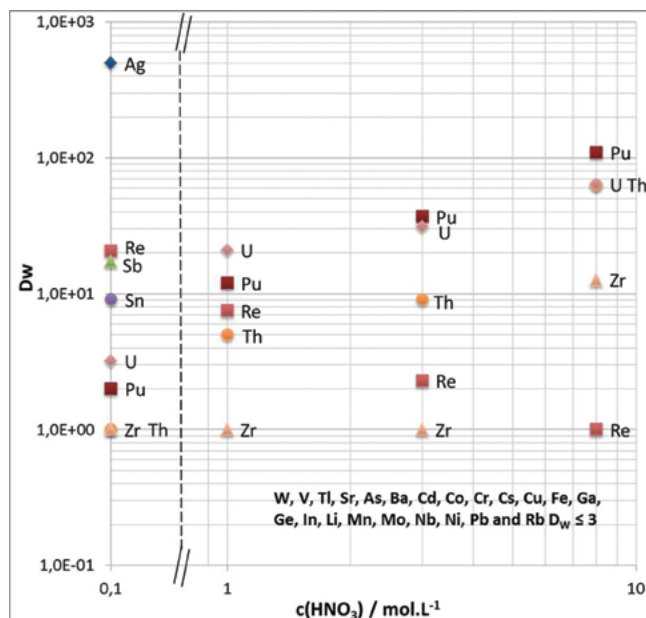
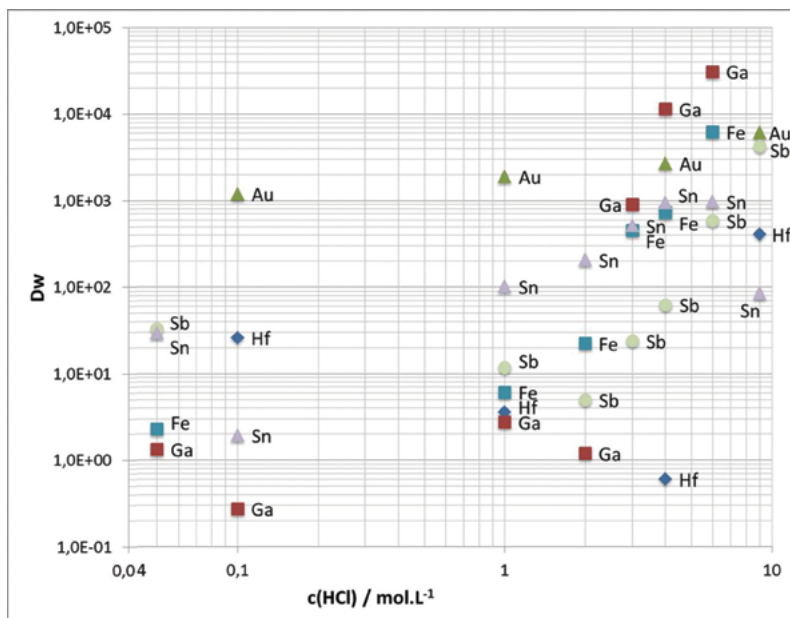

$D_w$  values of selected elements on TBP Resin in HCl and  $\text{HNO}_3$ .

The TBP Resin has further been characterized with respect to the uptake of various elements in  $\text{HNO}_3$  and HCl, the results are summarized in the two figures.

Beside Pu(IV) and Np(IV) several other elements such as Au, Hf, Fe, Sn and Ga also show high affinity for the TBP resin in HCl.

While Au remains retained under all tested conditions, making its elution rather difficult in HCl, the other elements only show high  $D_w$  values at elevated acid concentrations, and low  $D_w$  values at lower concentrations.

In 1 M HCl for example only Sn shows elevated  $D_w$

values whereas Fe, Ga, Sb... show very little affinity to the resin, allowing for its separation from these elements. Sn can then be eluted e.g. with 0.1M HCl.

The TBP Resin generally shows very good selectivity for Sn over Te [Te-126 is an isobaric interferences for the mass spectrometric determination of Sn-126, a long-lived beta emitter frequently determined in decommissioning and radioactive waste samples] and Cd which is frequently used as target material for the production of Sn-117m, a conversion electron emitter used in nuclear medicine. The resin also shows interesting selectivity for Sb, however its oxidation state needs to be carefully controlled.

In  $\text{HNO}_3$  of all tested elements only the actinides (at elevated  $\text{HNO}_3$  concentrations), and Ag (at low  $\text{HNO}_3$  concentrations), are retained on the resin. Based on the obtained data, Dirks et al. developed a procedure for the separation of Sn from various elements, the figure hereafter shows a scheme of the suggested method using a 2 mL TBP column.

Most of the tested elements are not retained during load and first rinse. Sn and part of the Ga and Fe are retained. The latter two are first removed with 1M HCl, Sn is then quantitatively eluted with 6mL 0.1M

HCl in high purity. For samples containing elevated amounts of Fe it will be necessary to either remove Fe before loading (e.g. by anion exchange) or to assure complete reduction of Fe to Fe(II).



#### Main Applications:

- Separation of tin
- Separation of actinides
- Separation of zirconium

Rinse 1: 7 mL 2M HCl

Alternative: 7 mL 2M HCl/0.1M HCOOH

Load: 5 to 20 mL 2M HCL

Alternative: 5 to 20 mL 2M HCl/0.1M HCOOH

② Rinse 2: 9 mL 1M HCl  
③  
④ Elution: 6 mL 0.1M HCl

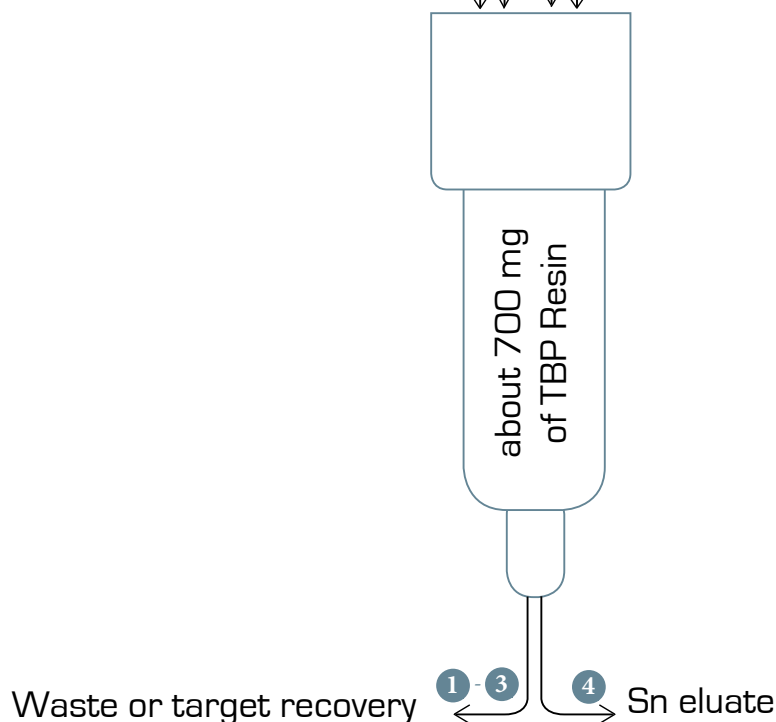

Separation scheme Sn separation on TBP Resin.

For additional information and references please have a look at the respective product sheets on our website:  
[www.triskem.com](http://www.triskem.com)



## TK100 Resin & TK 101 Resin

Crown-ether based extraction chromatographic resins such as the SR and PB Resins are frequently used for the separation and determination of Sr-90 and Pb-210 in aqueous samples via liquid scintillation (LSC) or gas proportional counting (GPC).

These resins only show significant Sr and Pb retention at moderate to high acid concentrations; thus not allowing for direct loading of the analytes from filtered raw or acidified water samples.

### TK100 Resin

The TK100 Resin consists of a crown-ether with high selectivity for Sr and Pb and HDEHP a liquid cation exchanger.

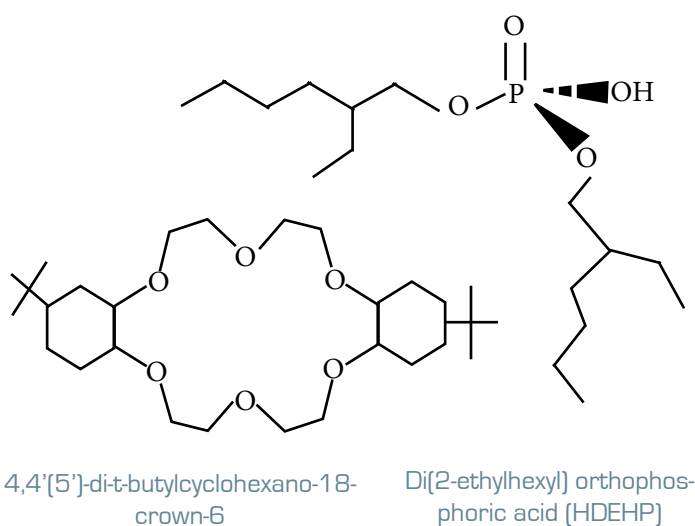

Jake Surman from Lancaster University characterized the resin with respect to  $D_w$  values of Sr at different pH values  $\geq$  pH 2, as well as at  $\text{HNO}_3$  and HCl concentrations higher than 0.01M. It could be shown that the resin shows high  $D_w$  values for Sr at pH values up to 8 ( $D_w \gg 100$ ).

As shown in the following figure, the Sr uptake at pH 2 is high, especially in  $\text{HNO}_3$ . The latter fact is of importance as water samples are often acidified to pH 2 using  $\text{HNO}_3$  directly after sampling in order to stabilize them for storage before analysis.

At elevated  $\text{HNO}_3$  concentrations the resin shows an increase of the Sr  $D_w$  values to about 100 at 8 - 10M  $\text{HNO}_3$ . The TK100 Resin is thus behaving very similar to the SR Resin under these conditions.

This makes the additional use of pre-concentration steps such as ion exchange or co-precipitation necessary.

In order to simplify the Sr-90 and Pb-210 separation, two new extraction chromatographic resins with an extended uptake pH range were developed, allowing for direct loading of water samples (pH 2 - 8) and the subsequent purification of the analytes on the same column.

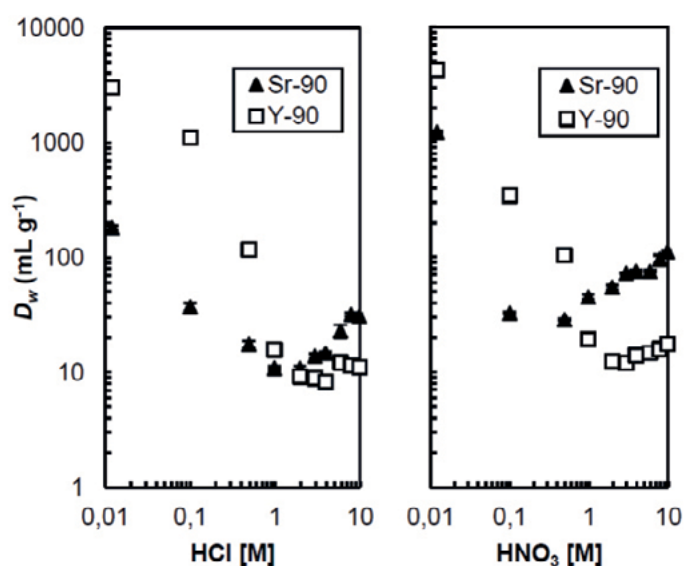

$D_w$  values Sr and Y on TK100 Resin, varying  $\text{HNO}_3$  and HCl concentrations

As Sr elution with water or dilute nitric acid is not possible, a number of other eluting agents were tested. 2M HCl, 3M HCl and 0.1M EDTA were found to be most suitable of all tested.

Several other elements also show an affinity to the TK100 resin at pH 7, making separation chemistry necessary in order to obtain a clean Sr fraction.

The influence of several typical matrix elements on its uptake onto the TK100 resin at pH 7 was tested. Even though high salt contents indeed interfere with Sr uptake, even at NaCl concentrations of 500 mM, K concentrations of 400 mg/L, Mg concentrations of 1300 mg/L and Ca concentrations of 500 mg/L the  $D_w$  values for Sr remain greater than 100.

Surman et al. could further show through elution studies that the resin allows for the separation of Sr from a number of elements such as Ca, K, Mg.

Even if the limiting concentrations will be lower for combinations of the interferences, the resin seems well suited for surface and especially drinking waters.

Surman et al. could further show through elution studies that the resin allows for the separation of Sr from a number of elements such as Ca, K, Mg, Ba, Co, Am, Cs and Pb. It should be noted that Pb is not eluting under the chosen conditions.

Additional studies performed by Dirks et al. with 1L samples at pH 7 loaded onto a 2 mL TK100 column in aliquots of 100 mL at a flow rate of 5 mL/min showed that K and Ca breakthrough during load without being retained.

Unfortunately Sr breakthrough starts occurring after a loading volume of approx. 600 mL indicating that the maximum sample volume to be loaded

onto the 2 mL column for Sr analysis is 500 mL.

Dirks et al. could indeed show that Sr can be separated with high yields from 250 mL (95.2% +/- 2.5%, N=3) - 500 mL (88.2 +/- 4.3, N=3) water samples with high yields even at sample loading flow rates of 5 - 10 mL/min. Y, Pb and U on the other hand are very well retained, even when a sample of 1L is loaded. Y can be quantitatively removed using 8M HNO<sub>3</sub>. Pb and U remain retained even after the Sr elution step and can be eluted using 6M HCl e.g. for Pb-210 determination via  $\alpha/\beta$  discrimination LSC.

Work on the separation of Pb and U on TK100 are ongoing, however, another resin called TK101 allows for facile separation of Pb from other elements.



**Main Applications:**

- Direct separation of Sr from water samples

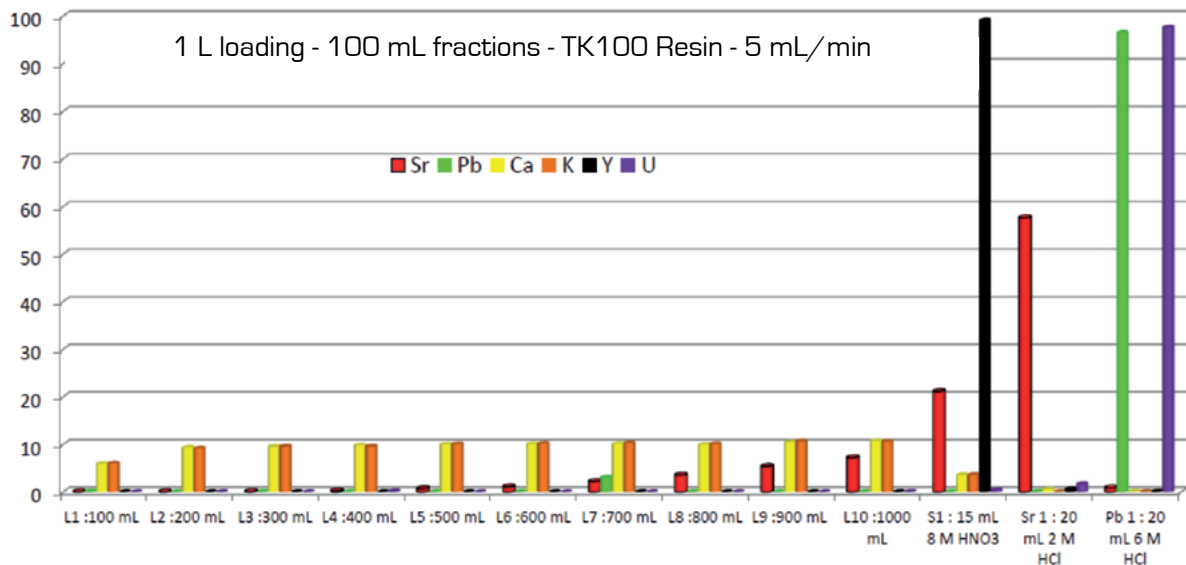

Elution study, various elements, 1L sample, 100 mL aliquots, TK100 Resin

## TK101 Resin

Dietz et al. showed that the mechanism of Sr extraction by crown-ethers in ionic liquids strongly depends on the chain-length of the ionic liquid. Long chained ionic-liquids favor liquid-liquid extraction mechanism with high Sr uptake at high nitric acid concentrations; whereas short chained ionic liquids introduce a cation exchange mechanism, leading to high Sr retention at low pH values. Sr retention then decreases with increasing acid concentrations to a minimum at about 1M HNO<sub>3</sub>. At higher HNO<sub>3</sub> concentrations the D<sub>w</sub> values increase as expected when liquid-liquid extraction mechanism becomes predominant.

This behavior corresponds very well to the behavior of the crown-ether / HDEHP system. However, as very little additional selectivity is introduced by the ionic liquid, compared with TK100 Resin, it

is much easier to obtain a clean Pb fraction. Unfortunately the Sr retention turned out to be significantly weaker than for the TK100 Resin, limiting the application of this system to the separation of Pb.

An elution study performed by Dirks et al. using the TK101 Resin showed that indeed a clean Pb fraction can be obtained applying a similar separation scheme as employed for the TK100 Resin. High Pb yields are obtained even when loading 1L samples or more at flow rates of 5 – 10 mL/min



**Main Applications:**

- Direct separation of Pb from water samples

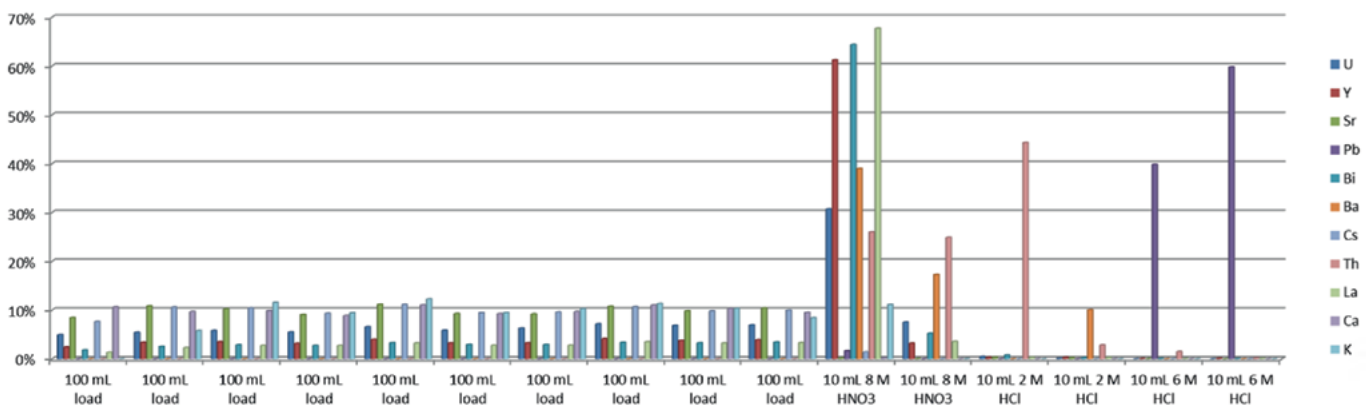

Elution study, 1L sample, 100 mL aliquots, TK101 Resin

## TK200 Resin

The TK200 Resin is based on TriOctylPhosphine Oxide (TOPO) an extractant widely used in the extraction of metal ions.

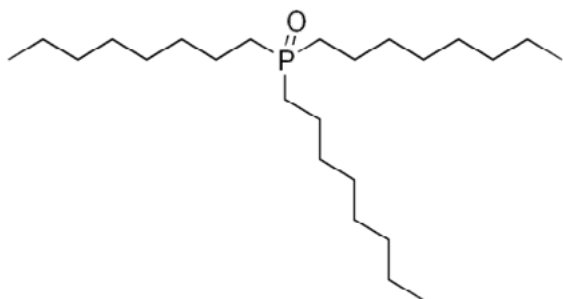

Trioctylphosphine oxide (TOPO)

Some examples of  $D_w$  values determined in  $\text{HNO}_3$  and HCl using ICP-MS are shown below.

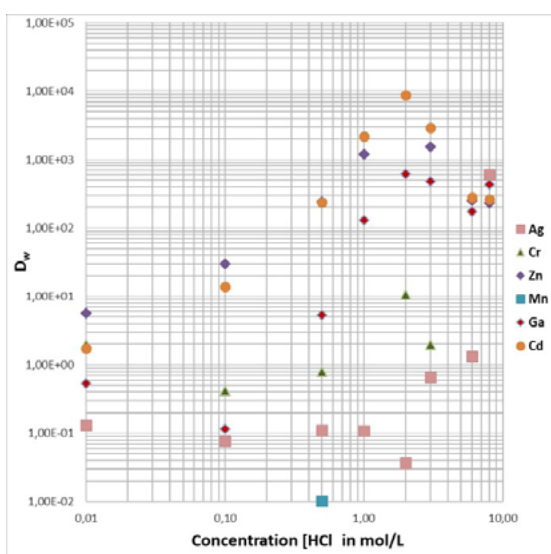

$D_w$  values of selected elements on TK200 Resin in HCl

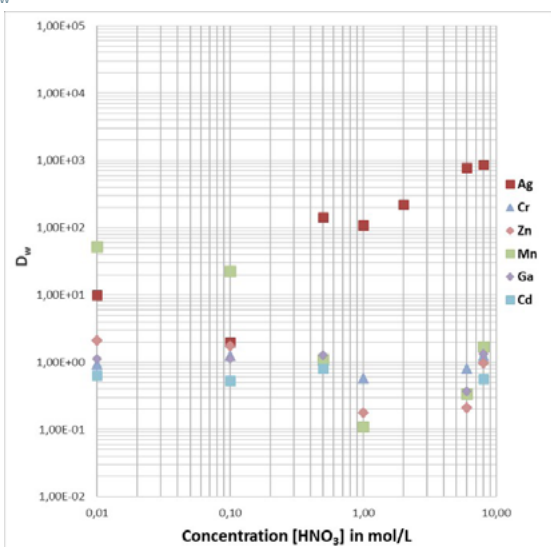

$D_w$  values of selected elements on TK200 Resin in  $\text{HNO}_3$

$D_w$  values for a wide range of additional elements may be found in the corresponding product sheet.

Cd, Zn and Ga are very well retained at HCl concentrations  $>1\text{M}$ . This is especially interesting with respect to Ga separation chemistry as Ga is

not retained at 1 – 2M HCl on most resins.

In  $\text{HNO}_3$  of the elements shown here only Ag is retained whereas e.g. Ga and Zn are not.

A typical example of the use of the TK200 Resin is the separation of Gallium isotopes (especially Ga-68) from irradiated Zn targets for medical use in combination with the ZR Resin.

ZR Resin is very well suited for the separation of Ga from Zn matrices, under low acid conditions (e.g. 0.1M  $\text{HNO}_3$  often employed for liquid targets) as well as at high acid concentrations (e.g. 10M HCl) conditions often used for the dissolution of solid Zn targets.

An elution study showing the separation of Ga from Zn and potential impurities on ZR Resin is hereafter:

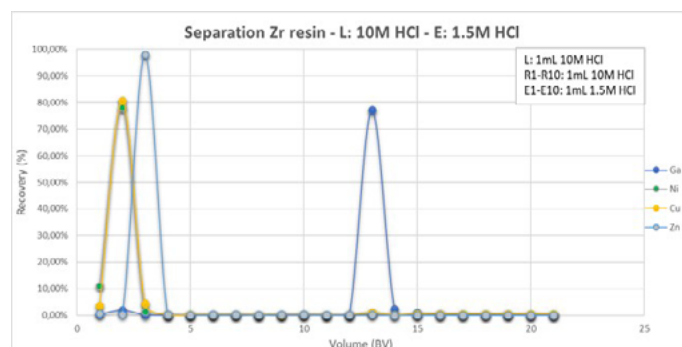

Ga/Zn separation on ZR Resin - load from 10M HCl

Ga is eluted from the ZR Resin in a small volume (1 – 2 column volumes) of 1.5M HCl, conditions too acidic for direct use in labelling reactions.

The TK200 Resin on the other hand allows for Ga extraction at 1.5M HCl, followed by Ga elution using aqueous solutions.

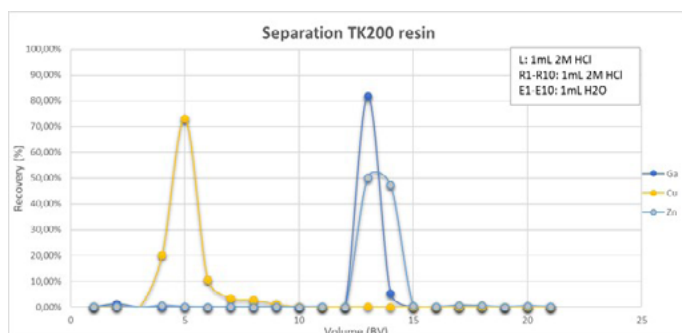

Ga elution from TK200 Resin with water following load from 1.5M HCl

It should be noted though that only very little additional Ga/Zn separation is taking place on the TK200 Resin.

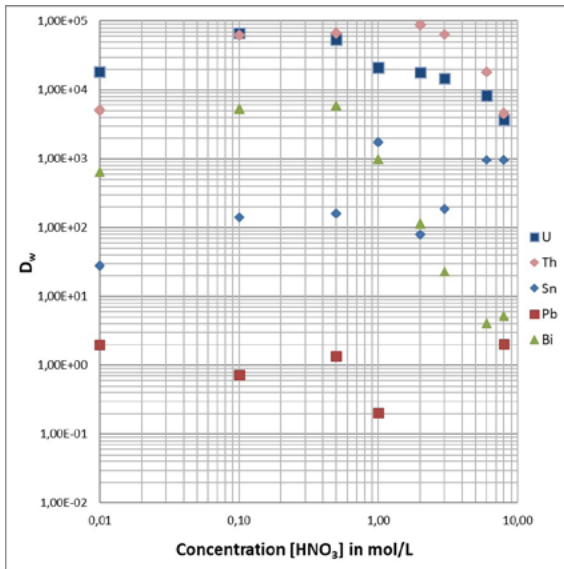

$D_w$  values of selected elements on TK200 Resin in  $\text{HNO}_3$

Another typical application of the TK200 Resin is the determination of actinides such as U, Th and Pu in water samples

As shown in the following figure, U and Th are very well retained over the whole  $\text{HNO}_3$  concentration range, including 0.01M.

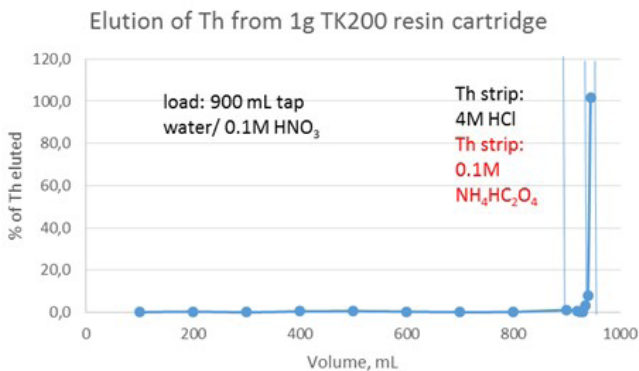

Elution study Th retention and elution on TK200 Resin (data courtesy of Nora Vajda)

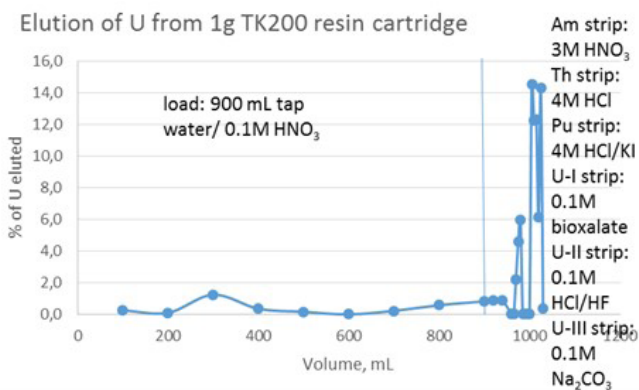

Elution study U retention and elution on TK200 Resin (data courtesy of Nora Vajda)

This allows for using the TK200 Resin for the preconcentration of actinides from acidified water samples, and their subsequent separation on the same column.

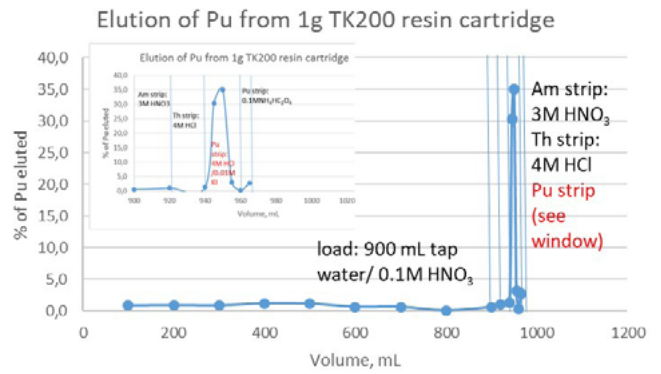

Elution study Pu retention and elution on TK200 Resin (data courtesy of Nora Vajda)

U and Th are also very well retained from HCl.

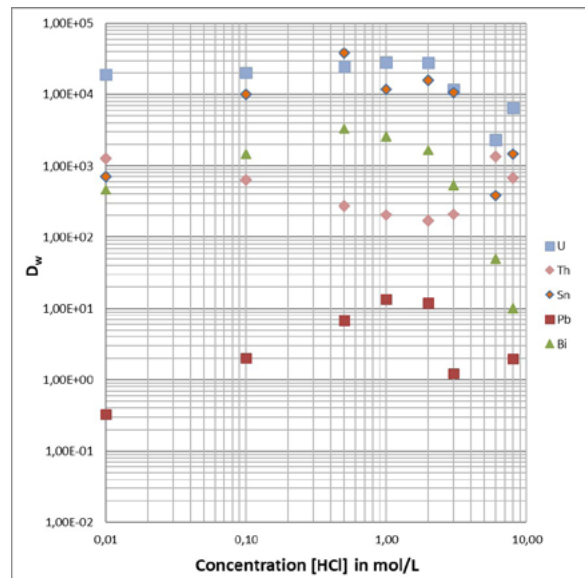

$D_w$  values of selected elements on TK200 Resin in HCl

By employing oxalic acid of suitable concentration a clean U/Th separation may be obtained as shown here:

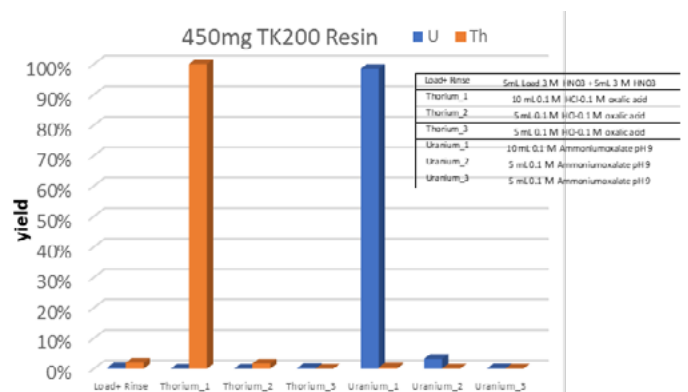

Elution study U/Th separation on TK200 Resin (data courtesy of Carina Dirks)



**Main applications:**

- Ga separation for radiopharmaceutical applications (in combination with ZR Resin)
- U, Pu, Th concentration and separation

# TK400 Resin

The TK400 Resin is an extraction chromatographic resin that is comprised of octanol impregnated onto an inert support. Knight et al. showed that long-chained alcohols, especially octanol, show very interesting selectivity towards Pa at high HCl concentrations, allowing for facile Pa/Np separation using column chromatography. Jerome and al. characterized the TK400 Resin with respect to its selectivity for

a number of elements including Pa, Np, U and Th.

They found that Pa retention sharply increases at high ( $\geq 9M$ ) HCl concentrations whereas other elements tested are not retained. At HCl concentrations  $< 8M$  HCl on the other hand  $D_w$  values of Pa were found to be low allowing for its elution in a small volume. Ostapenko et al. found a similar trend for Pa retention with  $k'$  values being high for Pa at high HCl concentrations (9M). These results correspond overall well to the selectivity observed by Knight et al. when performing Np/Pa separation.

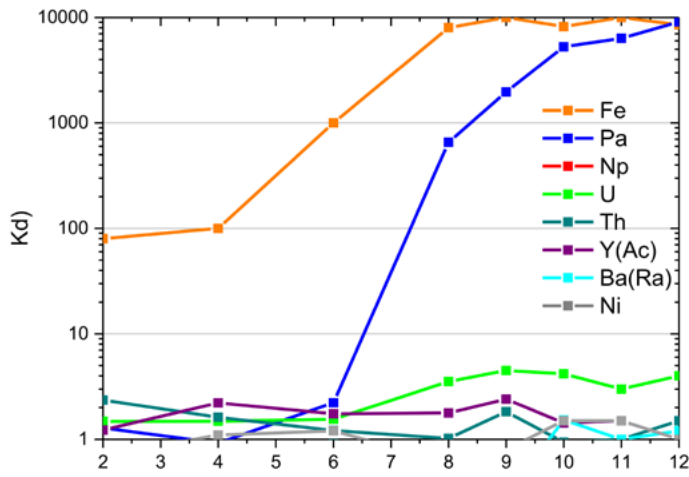

$D_w$  values of selected elements on TK400 Resin in HCl at varying concentration

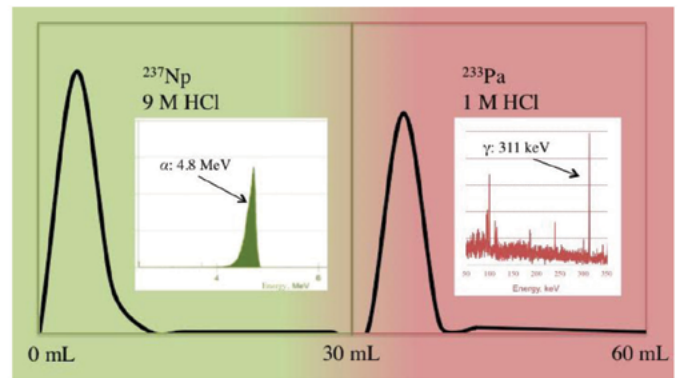

Elution study, Np/Pa separation on long-chained alcohol resin

The resin shows high selectivity for Nb at high HCl concentrations over other elements tested such as Ta, Zr, Hf and lanthanides which are not, or only very poorly as in the case of Ta, retained by the resin.

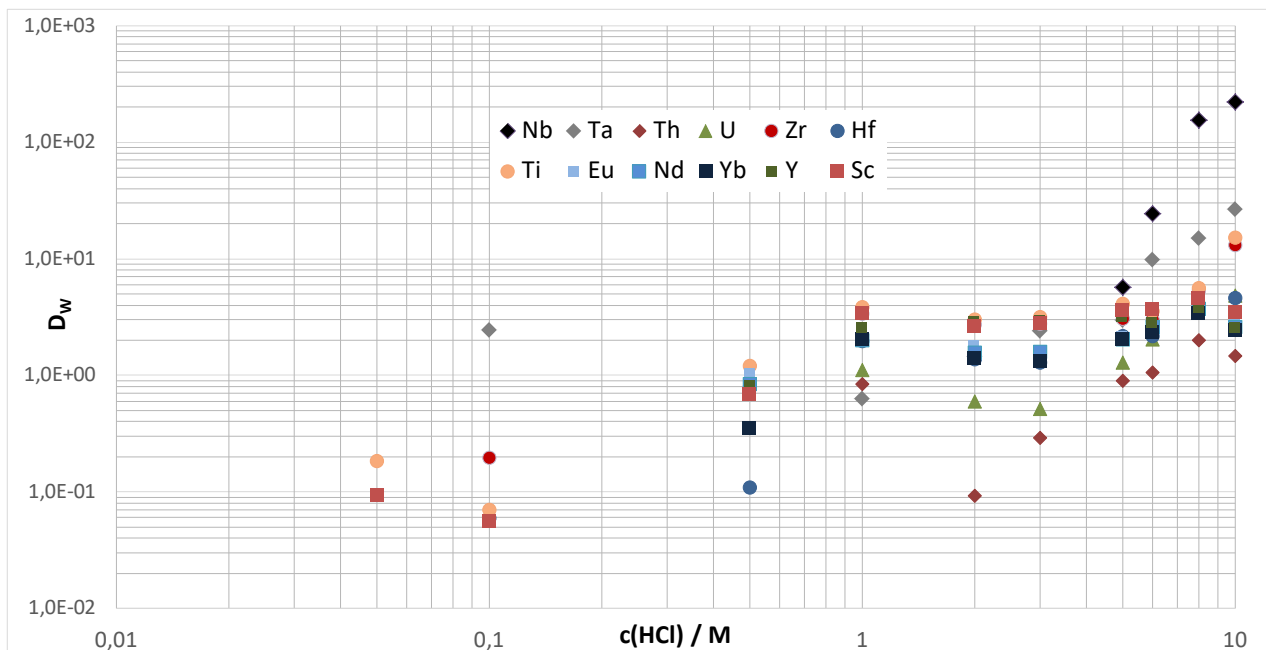

$D_w$  values of selected elements on TK400 Resin in HCl at varying concentration

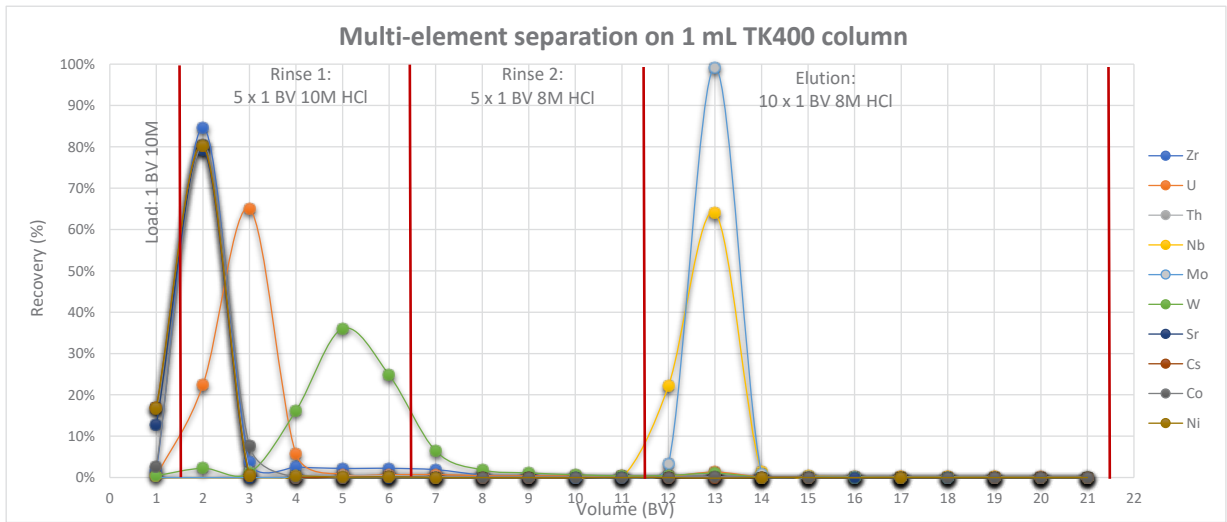

Elution study, Nb separation from selected cations, 2 mL TK400 column

With respect to its selectivity the TK400 Resin shows the potential for allowing a number of interesting separations such as Nb/Zr and Pa/U/Th. The results of an elution study on the separation of Nb from a number of elements, including Zr, and the separation method used to obtain these results are shown in following figures. Jerome et al. employed the TK400 Resin for the separation of Pa from its descendants following the procedure shown here. They found that U, Th, Ac, Ra and Pb were removed from the resin during load and rinse, allowing for obtaining a clean Pa fraction with high chemical yield (environ 83%).

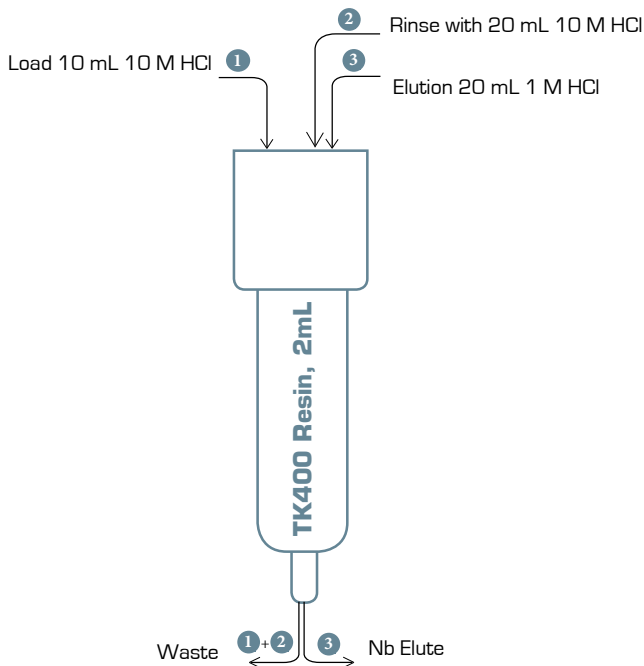
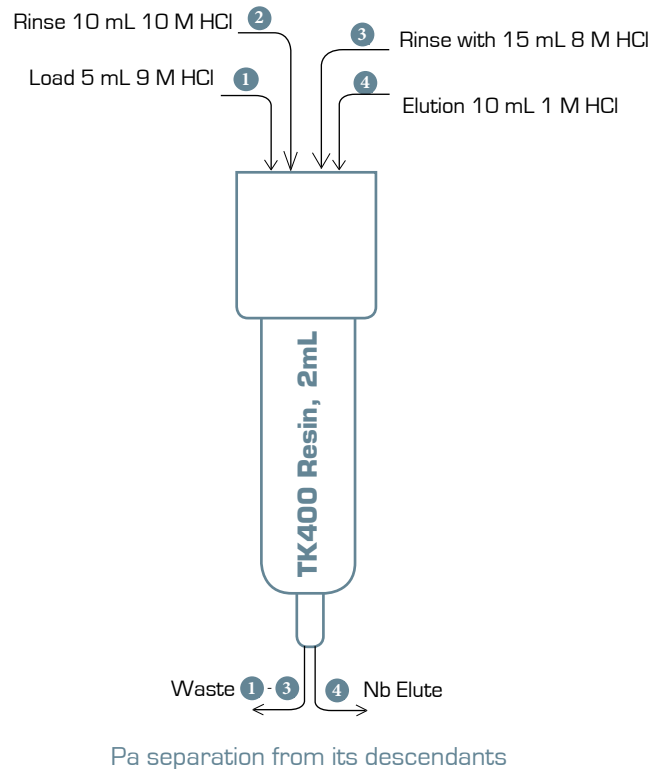

**Main Applications :**

- Separation of protactinium
- Separation of niobium

## AC Resin

AC Resin contains bis[2-ethylhexyl] methane-diphosphonic acid [ $H_2DEH[MDP]$ , DIPEX®] as extractant.

The Actinide Resin (AC Resin, in the literature also referred to as DIPEX® Resin) is mainly used for the preconcentration and separation of actinides from acidic solutions obtained from environmental samples (soil leachates and large volume water samples).

The AC Resin shows a higher affinity for actinides in general and in particular a better selectivity for americium, compared to its ion exchange analogue Diphonix®. This high affinity is also used for the determination of the gross alpha activity of urine and water samples via liquid scintillation counting.

The same resin is also used for the separation of beryllium from environmental and industrial matrices. It is used to purify Be from other elements that could interfere with its determination via ICP-AES. Be is strongly retained on the AC Resin between pH 1 and pH 2 and can be eluted using nitric acid of a concentration greater than 1M.

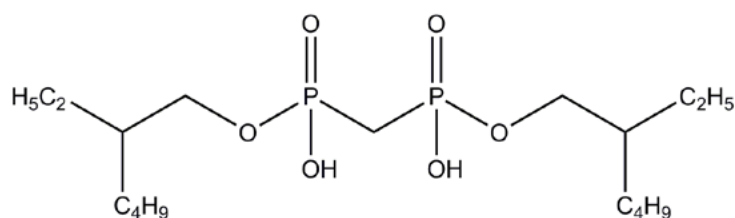

DIPEX® extractant

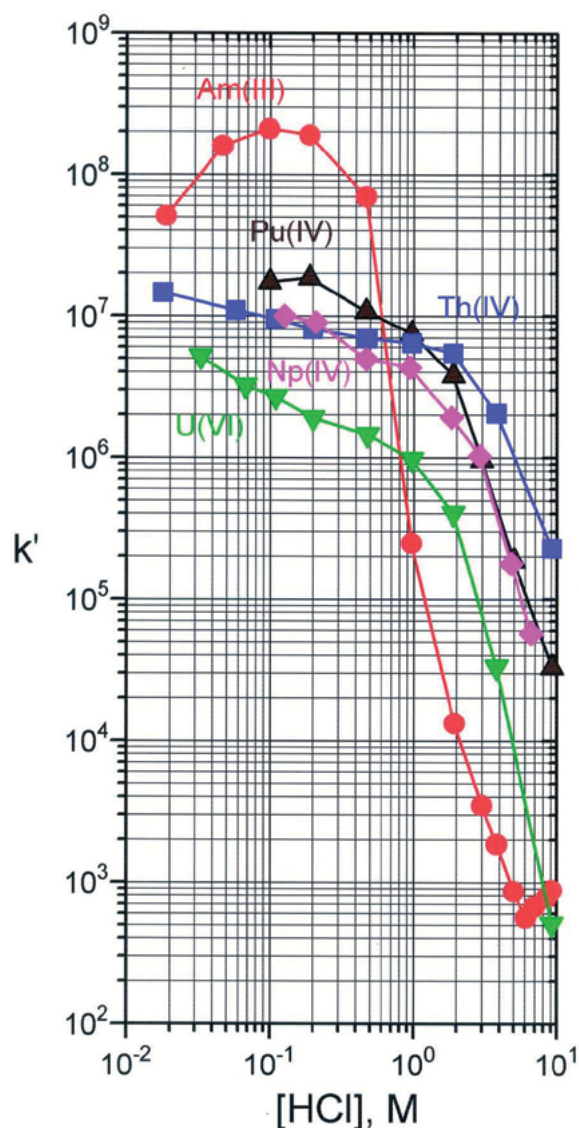

Acid Dependencies of the Uptake of Several Actinides by the Ac Resin

### Main applications :

- Gross-alpha activity in water and urine samples
- Preconcentration of actinides from environmental samples
- Separation of Be for ICP-AES measurement

## PREFILTER Resin

Prefilter Resin is a hydrophilic, macroporous, acrylic ester polymeric resin with a high surface area and a high capacity for various organic compounds.

The resin is mainly used for the removal of organic impurities from aqueous solutions, such as colourizing agents to avoid quench effects in liquid scintillation counting, or for the removal of co-eluted extractants from column or cartridge eluates which might interfere with electrodeposition.

### Main applications:

- Removal of organic impurities



## WBEC Resin

WBEC (Weak Base ExtractionChromatographic) Resin is based on a mixture of tertiary octyl and decylamines, also called Alamine® 336. It is mainly used for the separation of Technetium and Pu[IV].

Overall the WBEC Resin shows interesting selectivity for Tc and Pu and to a certain extent for tetravalent actinides; its selectivity is thus similar to TEVA Resin, however  $k'$  values of the tetravalent actinides are generally significantly lower.

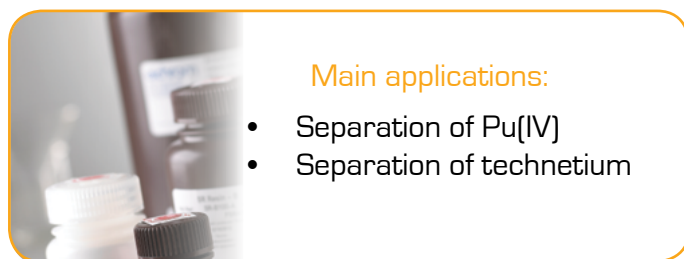

### Main applications:

- Separation of Pu(IV)
- Separation of technetium

In general the elution of the analytes is facilitated. Pu can be eluted with 1 M HCl or even slightly higher HCl concentrations and Tc with 1 M  $\text{NH}_4\text{OH}$  as shown by the figure hereunder.

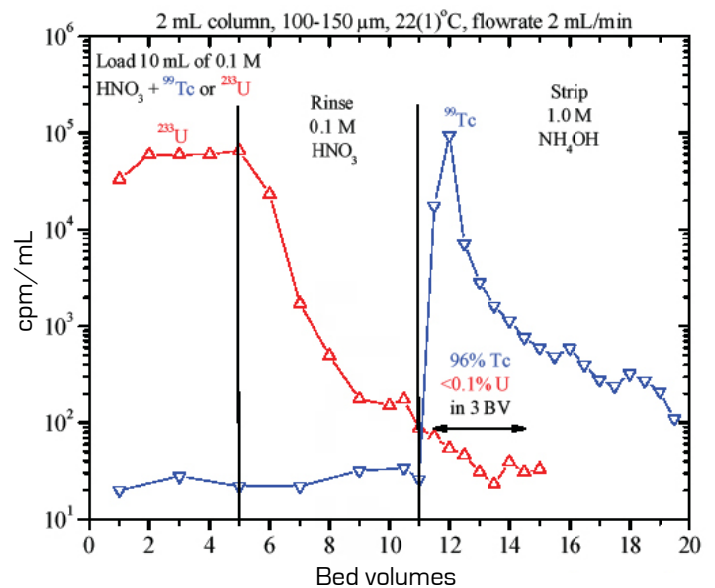

Elution study U/Tc separation

### $k'$ on Weak Base EC Resin 100-150 $\mu\text{m}$ , 22(1) $^\circ\text{C}$ , 1 hour equilibration

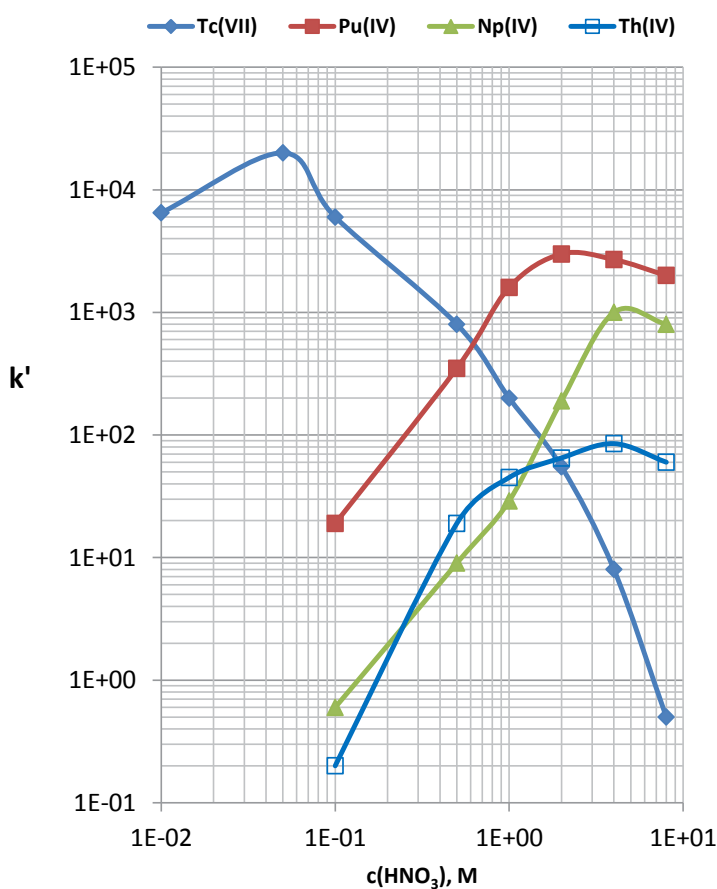

### $k'$ on Weak Base EC Resin 100-150 $\mu\text{m}$ , 22(1) $^\circ\text{C}$ , 1 hour equilibration

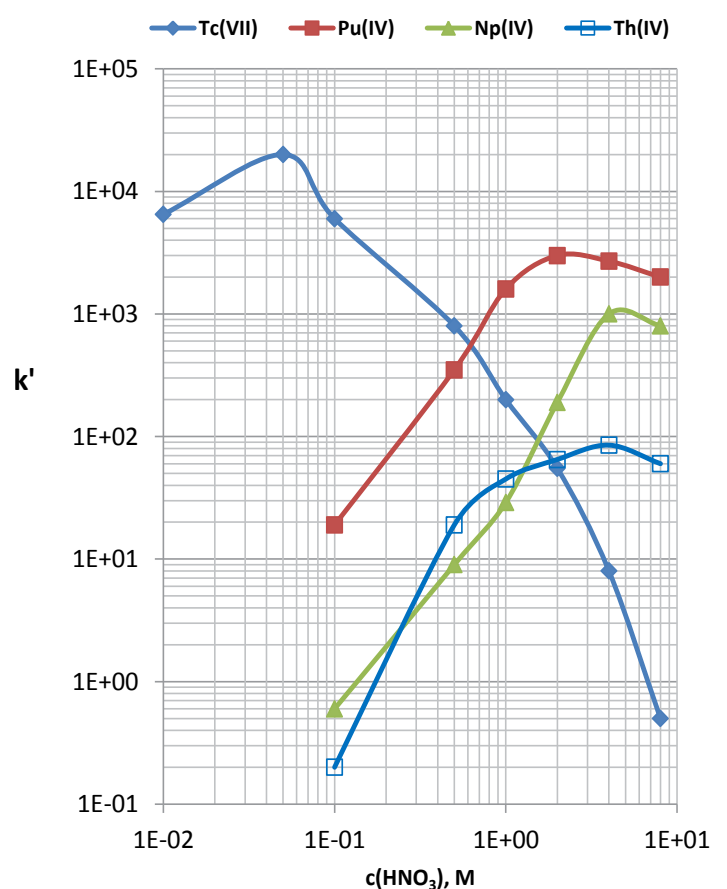

Acid Dependencies of the uptake of selected elements by the WBEC Resin

# SPECIALTY ION EXCHANGE RESINS

## MnO<sub>2</sub>-PAN Resin

The analysis of Ra isotopes in water samples is becoming more and more important. To meet existing requirements on detection limits, especially for Ra-228, elevated samples volumes have to be used for analysis. MnO<sub>2</sub> Resin allows to preconcentrate Ra isotopes efficiently from water samples, drinking water as well as sea water.

MnO<sub>2</sub> Resin is currently used with LN Resin and DGA Normal resin in a method developed by Sherrod Maxwell of Westinghouse Savannah River. In his method the MnO<sub>2</sub> is used to pre-concentrate Ra from 1 to 1.5L water samples, with 1.25 g/L of MnO<sub>2</sub> resin used per sample.

Ra is then eluted and loaded (in case Ra-228 is to be determined after a minimum of 36 hours for Ac-228 ingrowth) onto DGA, Normal Resin (retention/separation of Ac-228). Ac-228 is eluted from the DGA Resin and finally micro-precipitated with CeF<sub>3</sub>

and counted via GPC; the precipitated source can be used for gravimetric yield determination. Ra-226 can be determined, directly or after additional clean-up via LN Resin, by BaSO<sub>4</sub> micro-precipitation and alpha spectrometry.

TrisKem International is providing the MnO<sub>2</sub>-PAN resin (G2 Resin) developed by Dr. Šebesta (CVUT).

It consists of very fine MnO<sub>2</sub> particles embedded into a modified polyacrylonitrile (PAN) binding polymer offering a very stable MnO<sub>2</sub> resin with a very high surface area.

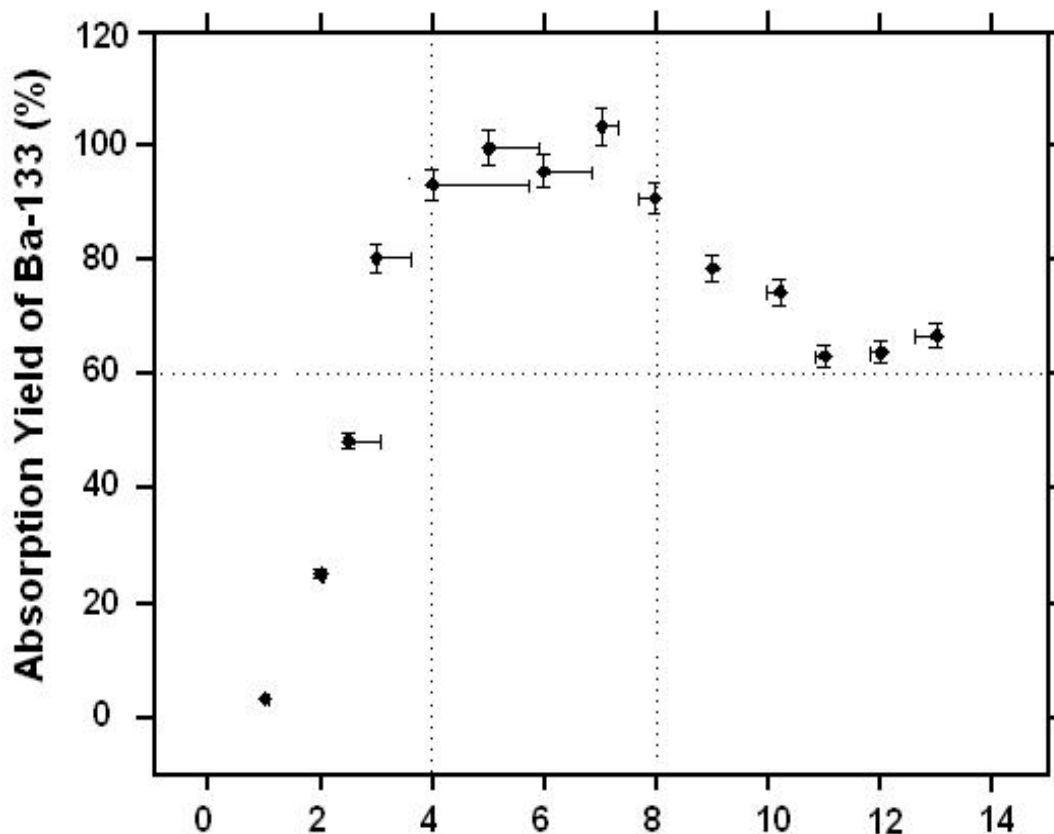
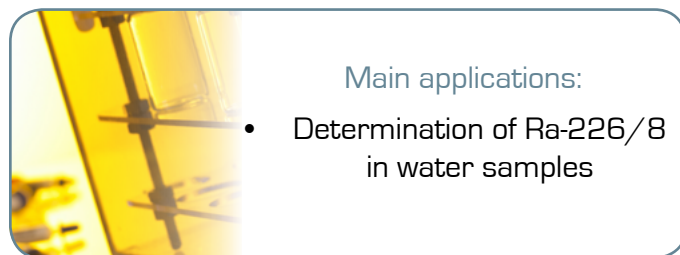

Absorption of Ba-133 on MnO<sub>2</sub> Resin

## Determination of Ra-226/8 in water samples, modified version of Eichrom method RAW04-10

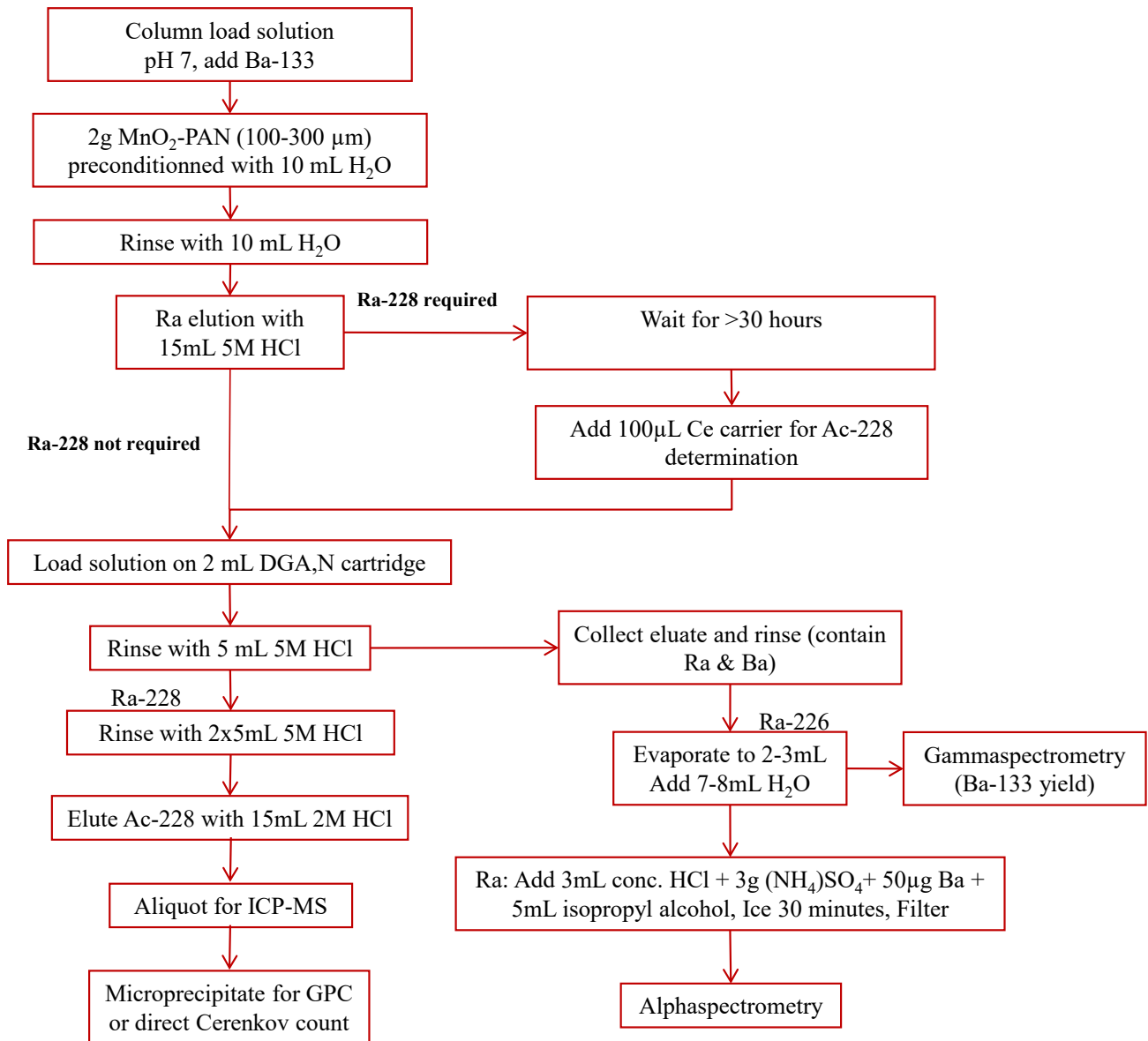

## Cs Resins

Both resins, AMP-PAN and KNiF-PAN have been developed by Dr. Šebesta from the Czech Technical University in Prague. Like the  $MnO_2$ -PAN resin both resins are based on very fine and selective inorganic materials embedded in an organic matrix based on polyacrylonitrile (PAN) in order to improve their mechanical characteristics. The active components are the widely employed ammonium phosphomolybdate (also Ammonium MolybdoPhosphate, AMP) and potassium nickel hexacyanoferrate(II) (also potassium Nickel FerroCyanate, KNiFC).

Both resins are used for the concentration and separation of Cs from various liquid samples.

Ammonium phosphomolybdate is an inorganic ion exchanger known for its high selectivity for Cs even at elevated acid concentrations, quick kinetics and radiation stability.

Its high selectivity for Cs even under harsh chemical conditions and high levels of radioactivity make the AMP-PAN resin a candidate resin for the treatment of radioactive waste solutions. Brewer et al. tested the resin for the removal of Cs-137 from real and simulated acidic high-active liquid radioactive waste containing high amounts of potassium and sodium.

AMP-PAN's robustness against high salt concentrations also makes it interesting for use in environmental analysis, especially the analysis of Cs-134/7 in sea water. Kamenik et al. evaluated AMP-PAN and KNiFC-PAN resins for use in Cs-134/7 analysis in sea water samples.

The authors passed 100L of acidified seawater samples (in case of KNiFC-PAN unacidified seawater samples were tested as well) through 25 mL beds of AMP-PAN or KNiFC-PAN resin at flow rates up to 300 mL.min<sup>-1</sup> allowing for processing 100L samples in less than 6h. Stable Cs was added to the seawater samples to allow for the determination of the chemical yield e.g. via ICP-MS.

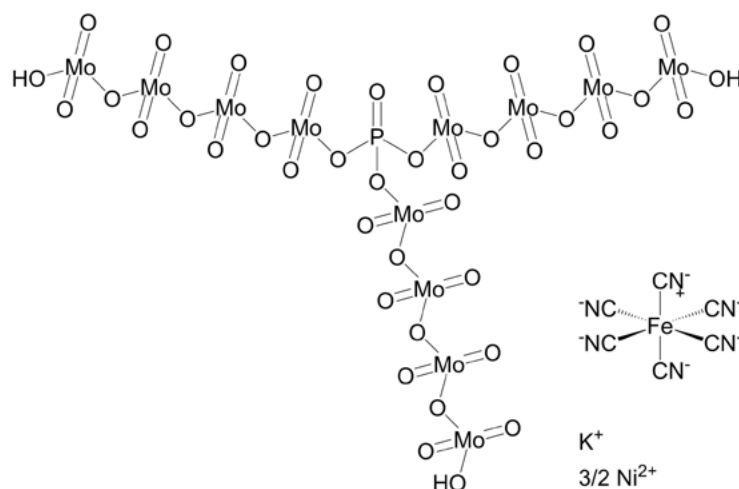

Ammonium MolybdoPhosphate (AMP) and potassium Nickel FerroCyanate (KNiFC)

After loading resins were rinsed from the columns, dried and measured by gamma spectrometry in Petri dish geometry. Chemical yields obtained are generally high (>90%), KNiFC-PAN showing slightly higher yields for the acidified seawater samples than AMP-PAN resin and comparable chemical yields for acidified and non-acidified seawater samples. Higher flow rates were tested for the processing of non-acidified sea water samples on KNiFC-PAN resin; even at a flow rate of 470 mL.min<sup>-1</sup> Cs yield is still greater than 85%.

KNiFC-PAN resin was further used for the determination of Cs isotopes in milk and urine.

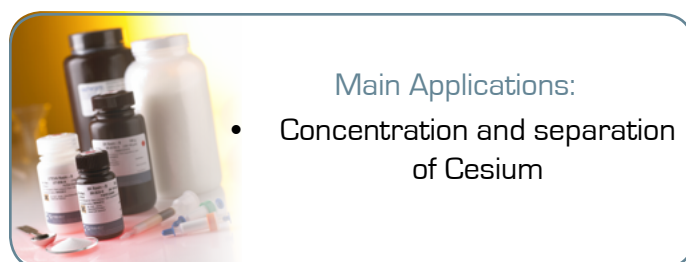

### Main Applications:

- Concentration and separation of Cesium

# ANALYTICAL GRADE ION EXCHANGE RESINS

## Anion and Cation Exchange Resins for Analytical Applications

TrisKem supplies an expanding range of cation and anion exchange resins, purified for the needs of analytical applications. Our analytical grade ion exchange resins are purified with successive rinsing of methanol, NaOH and HCl to remove residual organic molecules remaining from the manufacturing processes in order to provide you with a high quality product. The line of cation exchange resins for analytical applications are type 50W strong acid cation exchange resins [sulfonic acid exchange groups on styrene divinyl benzene polymeric beads]. The resins are available in 4% and 8% DVB cross linkages. All cation exchange resins are provided in hydrogen form and are supplied in the following dry mesh ranges: 50 - 100, 100 - 200, and 200 - 400.

The line of analytical anion exchange resins are type 1 strong base anion exchangers [quarternary amine functional groups on styrene divinyl benzene polymeric beads.] DVB cross linkages of 4% and 8% are currently available in dry mesh sizes of 50 - 100, 100 - 200, and 200 - 400. All resins are available in the chloride form.



**Main applications :**

- Preconcentration of cations (e.g. Sr, Pb)
- Separation of Pu

## Monophos Resin

Monophos Resin is based on a Polystyren-DVB support functionalized with monophosphonic acid.

The Monophos Resin mainly finds use in process scale applications. Within these applications it is most frequently used in order to control of the Fe(III) concentration in Cu, Ni and Co electrowinning electrolytes.

It further allows retaining actinides in the oxidation states III, IV and VI. At the same time other cations which are frequently found in environmental samples (e.g. Ca and Fe(II)) are not well retained, accordingly it may be used to preconcentrate actinides from leached soil samples.

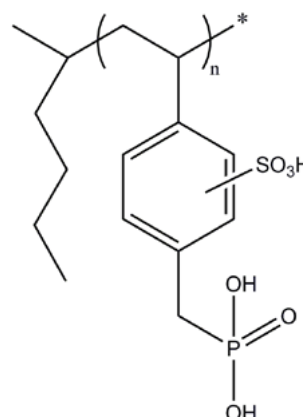

**Main applications:**

- Fe(III) removal from Cu electrowinning solutions
- Preconcentration and removal of actinides

# Tritium Columns

Tritium columns (H-3 columns) are used for the separation and determination of free tritium as tritiated water and are an alternative to direct measurement or measurement after distillation. Since the columns are not concentrating tritium, they can only be used when the required detection limit can be obtained by measurement of a sample volume of 5 – 10 mL. The free tritium is eluted from the column while other elements of the matrix are retained on the three components of the Tritium column.

The Diphonix resin retains cations in exchange of protons; its theoretical capacity is 0.8 mEq per column.

The 1X8 anion exchange resin (Cl<sup>-</sup> form) retains anions that might interfere with the Tritium measurements. Its theoretical capacity is 0.8 mEq per column. It is recommended to work at sample pH values greater than 1. The Prefilter Resin is used

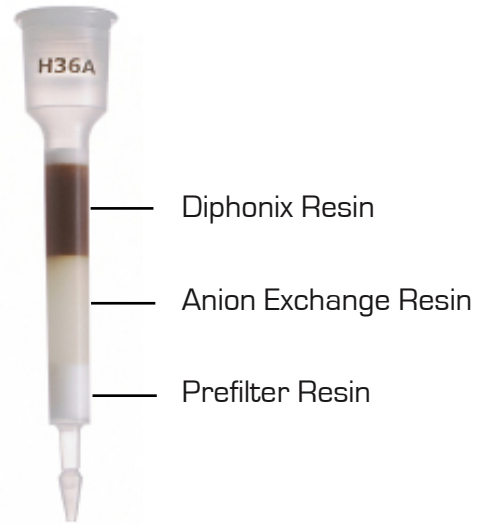

Tritium column



**Main applications:**

- Determination of H-3 in aqueous samples

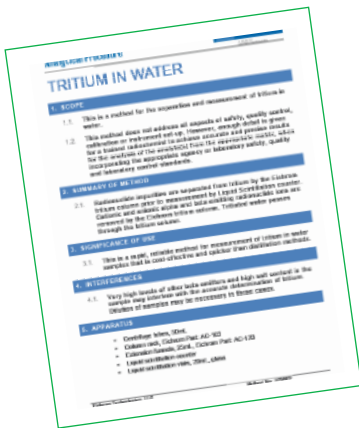

Ready to use method H3W02 Tritium in water available at:  
[www.triskem.com](http://www.triskem.com)

# SAMPLE PREPARATION

## Nucfilm Discs

Recent improvements in the fabrication of  $MnO_2$  layers by Dr. Heinz Surbeck (Nucfilm GmbH) now allow the fabrication of selectively adsorbing  $MnO_2$  coated as a thin film onto the surface of a polyamide disc. These coated substrates are available as Ra NucfilmDiscs. Due to their high selectivity for Ra the discs allow the direct determination of Ra isotopes in water samples without applying additional radiochemical separation methods.

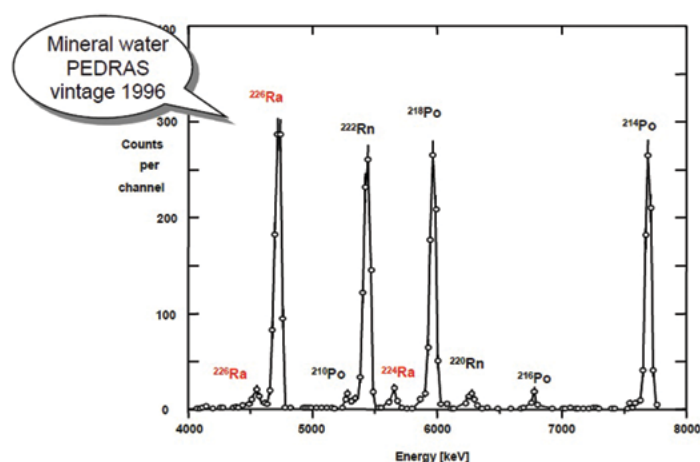

Alpha spectrum of a radium adsorbing thin film exposed to a Portuguese mineral water.

The discs are contacted with the untreated water samples (pH 4 – 8, typical volume = 100 mL) under stirring for 6h. Under these conditions the Ra extraction is typically greater 90%. The dried disc can then be measured with a solid state alpha detector.

The energy resolution of the obtained sources is very good as demonstrated in the following figure, typically FWHM in the order of 30 to 40 keV are obtained. The analysis of a 100 mL sample (counting time  $t = 80000$  s,  $900$  mm<sup>2</sup> Si-detector at 10 mm distance) typically results in a detection limit (LLD) of  $5$  mBq.L<sup>-1</sup> for Ra-226.



Main applications:

- Determination of Ra-226 in water samples

## Resolve™ Filters

Filters typically are manufactured to meet specifications for removal of particles to result in defined solution purity characteristics.

For example, a  $0.1\mu m$  rated pore size filter is typically defined as capable of removing 99.98% of particles  $0.1\mu m$  from a liquid. The pores present on the surface, however, may be much larger or smaller than  $0.1\mu m$ . Maximum peak resolution in alpha spectroscopy requires a filter surface as uniform as possible to ensure a uniform deposition of the rare earth fluoride precipitate.

Resolve™ filters ( $0.1\mu m$  polypropylene, 25 or 47 mm diameter) are manufactured to specifications appropriate for alpha source preparation in order to allow obtaining alpha spectra with high resolution. The 25 mm Resolve® filters are also available in filtration units for use with vacuum boxes

## Discs for alpha spec source preparation

TrisKem is providing stainless steel discs for electrodeposition source preparation. Silver and nickel discs as well as an auto-deposition kit are available for the particular case of polonium auto-



Ra Nucfilm Disc

Nickel Disc

Silver Disc



Resolve filters



Auto-deposition kit

# ACCESSORIES

## Vacuumbox and accessories

Vacuum-assisted separation setups based on a vacuum box and cartridges are gaining increasing popularity. TrisKem provides 12 and 24 position vacuum boxes, empty 2 and 10 mL cartridges, associated accessories such as reservoirs, valves allowing for individual flow rate adjustment and spare parts for the vacuum box.



Column funnels

Yellow outer tip and flow-rate regulation valve



10 ml and 25 ml reservoirs



Empty 2 ml and 20 ml columns

## Column accessories

In order to allow our users to pack columns themselves TrisKem provides empty 2, 5 and 20 mL columns. We further provide funnels (20 mL for 2mL columns and 250 mL for 5 -20 mL columns) and racks (for 2 mL columns and for 5 - 20 mL columns) for empty and prepacked columns.

## ICP-MS standards and consumables

TrisKem now also provides traceable single and multi element standards for ICP-MS, ICP-AES and AAS, as well as quartz ware e.g for ICP-MS.

We are also offering lab ware and consumables (beakers, filtration units, filters,..) needed to perform your analysis

## Bio-Safe PEEK columns

Bio-Safe columns are biocompatible and precision-machined from virgin PEEK (polyetheretherketone), a strong, inert polymer material. The columns are metal free for use in ion chromatography applications.

- Biocompatible.
- Metal free.
- Stable to 550 bar
- 2.1 and 4.6 mm inner diameter
- Wide range of column lengths
- 2.0  $\mu\text{m}$  PEEK frits







## Pyrolyser-6 Trio

### Raddec Pyrolyser-Trio Furnace System

Efficient and rapid extraction of tritium and C-14 from any material

The Pyrolyser-6 Trio & Pyrolyser-2 Trio furnace systems have been scientifically designed and evaluated to provide a safe and efficient means of extracting H-3 and C-14 (and other volatile radionuclides) from almost any type of sample (foodstuffs, biota, soil, sediment, concrete and other building materials, metals and bioassay samples)



## Pyrolyser Mini

### Raddec Pyrolyser Mini Furnace System

A compact furnace for the efficient and rapid extraction of H-3 and C-14 from any material.

The Pyrolyser Mini system is a compact two stage combustion furnace designed to complement the existing Pyrolyser-Trio family of combustion furnaces. The Pyrolyser Mini has been designed to be compact enabling the system to be installed and operated in confined spaces.

# REFERENCES

- J. L. Cortina and A. Warshawsky Ion Exchange and Solvent Extraction; Marinsky, J.A., Marcus, Y., Eds.; Marcel Dekker: , 1997; Vol. 13, p.195.
- M. L. Dietz, E. P. Horwitz, and A. H. Bond," Metal in Separation and Preconcentration: Progress and Opportunities, Bond, A. H., Dietz, M. L., , R.D., Eds.; ACS Symposium Series 716, ACS, , 1999, pp. 234-250.
- E. P. Horwitz, R. Chiarizia, and M. L. Dietz, Solvent Extr. Ion Extr. 1992, Vol. 10, pp. 313-336.
- E. P. Horwitz, M. L. Dietz, R. Chiarizia, H. Diamond, S. L. Maxwell, III, and M. R. Nelson, Anal. Chim. Acta 1995, Vol. 310, pp. 63-78.
- E. P. Horwitz, R. Chiarizia, and M. L. Dietz, Reactive and Functional Polym. 1997, Vol. 33, pp. 25-36.
- E. P. Horwitz and C. A. A. Bloomquist, J. Inorg. Nucl. Chem. 1972, Vol. 34, pp. 3851-3871.
- E. P. Horwitz and C. A. A. Bloomquist, J. Inorg. Nucl. Chem. 1973, Vol. 35, pp. 271-284.
- E. P. Horwitz, M. L. Dietz, R. Chiarizia, and R. C. Gatrone and A. M. Essling, R. W. Bane, and D. Graczyk, Anal. Chim. Acta 1992, Vol. 266, pp. 25-37.
- E. P. Horwitz, R. Chiarizia, M. L. Dietz, H. Diamond, and D. M. Nelson, Anal. Chim. Acta 1993, Vol. 281, 361-372.
- E. P. Horwitz and C. A. A. Bloomquist, J. Inorg. Nucl. Chem. 1975, Vol. 37, pp. 425-434.
- E. P. Horwitz, M. L. Dietz, S. Rhoads, C. Felinto, N. H. Gale and J. Houghton, Anal. Chim. Acta 1994, Vol. 292, pp. 263-273.
- W. C. Burnett, D. R. Corbett, M. Schultz, E. P. Horwitz, R. Chiarizia, M. Dietz, A. Thakkar, and M. Fern, J. Radioanal. Nucl. Chem. 1997, Vol. 226, p. 121.
- Horwitz E.P., McAlister D.R., Bond A.H., Barans R.E., Solvent Extrac. Ion Exch., 23, 219 (2005).
- Horwitz E.P., Bond A.H., Barans R.E., McAlister D.R., 27th Actinide separations Conferences, (2003).
- Moon D.S., Burnett W.C., Nour S., Horwitz P., Bond A., Applied Rad. Isot., 59, 255 (2003).
- Maxwell, S.L., presented at Eichrom's North American Users' Meeting, , May 3, 2005, see [www.eichrom.com](http://www.eichrom.com).
- Cahill D. F., Peedin L. M., presented at 41st Annual Conference on Bioassay, Analytical and Environmental Chemistry, Eichrom workshop, Boston, MA – USA
- Esser B.K. et al., Anal. Chem., Vol.66, 1736 (1994)
- McAlister D., Horwitz E.P., Solvent Extrac. Ion Exch, 25 (6), 757–769 (2007)
- A. Zulauf, S. Happel, M. B. Mokili et al, J. Radanal Nucl Chem, 286(2), 539-546
- P E Warwick, A Zulauf, S Happel, I W Croudace, presented at the 11th ERA Symposium, 16/09/2010, Chester (UK), see [www.triskem.com](http://www.triskem.com)
- C. Dirks, B. Scholten, S. Happel et al., J Radioanal. Nucl. Chem, 286 (2010) 671-674
- C. Dirks, S. Happel, presented at the Triskem International users group meeting, 14/09/2010, Chester (UK), see [www.triskem.com](http://www.triskem.com)
- Chiarizia, R., Sep. Sci. Technol., 32, 1997, 1 – 35
- Kim G., Burnett W.C., Horwitz E.P., Anal. Chem., 72, 2000, 4882-4887
- Shaw D.R. et al., JOM, July 2004, 38 – 42
- Hines, J.J.; et al, Sep Sci Technol, 30(7-9), 1995, 1373 – 1384
- Surbeck H., presented at ICRM Conference on Low Level Radioactivity Measurement Techniques 18-22nd October 1999, Mol, Belgium, see [www.nucfilm.com](http://www.nucfilm.com)
- Mendes M, Aupiais J, Jutier C, Pointurier F. Anal Chim Acta. 2013 May 30;780:110-6
- Horwitz E.P., Dietz M.L., Rhoads S., Felinto C., Gale N.H., Houghton J.; Analytica Chimica Acta, Vol.292, p263-273 (1994)
- Nottoli E, Bienvenu P, Labet A, Bourlès D, Arnold M, Bertaux M. Appl Radiat Isot. 2014 Apr;86:90-6. doi: 10.1016/j.apradiso.2014.01.010.
- Horwitz P, McAlister D. Old Separations on New Resins and New Separations on Old Resins. RRMCM, Destin, FL 2008
- Sebesta F, Stefula V (1990) Composite ion exchanger with ammonium molybdophosphate and its properties. J Radioanal Nucl Chem 140(1):15 - 21
- Brewer et al. (1999). Czechoslov J Phys 49(S1):959-964
- Kamenik et al. (2012) J Radioanal Nucl Chem. DOI 10.1007/s10967-012-2007-4
- Kamenik J et al. (2009) Long term monitoring of Cs-137 in foodstuffs in the Czech Republic. Appl Radiat Isot 67(5):974-977
- Bartuskova et al. (2007) Ingestion doses for a group with higher intake of Cs-137. IRPA regional congress for Central and Eastern Europe, Brasov, Romania
- E. P. Horwitz, M. L. Dietz, R. Chiarizia, H. Diamond, S. L. Maxwell, III, and M. R. Nelson, Anal. Chim. Acta 1995, Vol. 310, pp. 63-78.
- Mark L. Dietz, Julie A. Dzielawa, Ivan Laszak, Blake A. Young and Mark P. Jensen: „Influence of solvent structural variations on the mechanism of facilitated ion transfer into room-temperature ionic liquids”, Green Chemistry, 2003, 5, 682–685
- Dirks et al.: “On the development and characterisation of an hydroxamate based extraction chromatographic resin”. Presented at the 61st RRMCM, October 25th - 30th, 2015, Iowa City, IA, USA



Please contact us at [contact@triskem.fr](mailto:contact@triskem.fr) for :

Free samples of our products to allow you testing them in your laboratory  
Any technical question concerning our products and methods  
Our support to implement our products in your laboratory  
R&D cooperation and the commercialisation of technologies you've developed

Products	Applications*
UTEVA® Resin	U, Th, Np, Pu
TRU Resin	Fe, Pu, Am/Cm, Th, Pa, U, Np
TEVA® Resin	Tc, Th, Np, Pu, Am/lanthanides
SR Resin	Sr, Pb
PB Resin	Pb
DGA Resins	Am, Actinides, Y, Ra/Ac
DGA Sheets	Quality control of Ra-223, Pb-212, Ac-225/Bi-213, Ge-68/Ga-68
LN Resin Series	Lanthanides, Ra-228
NI Resin	Ni
RE Resin	Rare earth, Th, U, Np, Pu, Am, Cm
CL Resin	Cl, I, Ag
CU Resin	Cu
ZR Resin	Zr, Ti, Ge, Ga, Nb
TBP Resin	Sn, Actinides, Zr
TK100 Resin	Sr (direct separation)
TK101 Resin	Pb (direct separation)
TK 200 Resin	Ga-67/8, Actinides
TK 400 Resin	Pa, Nb, Mo
AC Resin	Actinides separation/ gross alpha measurement, Be
Pre-Filter Resin	Organic traces removal
WBEC Resin	Tc, Pu
MnO <sub>2</sub> PAN Resin	Ra
CS Resins	Cs-134,7
Analytical grade Ion Exchange Resins	Preconcentration
Monophos Resin	Actinides and transition metals
Actinides and transition metals	H-3
Nucfilm discs	Ra
Resolve™ Filters	Microprecipitation
Stainless steel discs	Electrodeposition
Ag and Ni discs	Po autodeposition

\*Main applications are shown in grey

**Also available:**

ICP-MS standards  
LSC cocktails



TrisKem International

3, Rue des Champs Géons - 35170 Bruz - FRANCE

Tel +33 (0)2 99 05 00 09 - Fax +33 (0)2 23 45 93 19 - www.triskem.com - email : contact@triskem.fr

SAS au capital de 100.000 euros - SIRET 493 848 972 00029 - APE2059Z - TVA intra communautaire FR65 493 848 972